

Panasonic

Telephone Answering System
with Facsimile

Model No.

KX-FT37NZ

Quick Start



To get started,
please read the
Quick Start section.

Initial Preparation

Telephone

Fax/Copy

Answering Device

Help

General Information

OPERATING INSTRUCTIONS



Please read these Operating Instructions
before using the unit and save for future
reference.

Thank you for purchasing a Panasonic Facsimile.

Welcome to the world of Panasonic facsimiles.

This product combines the facsimile, telephone, telephone answering device and copier features, to provide you with more efficient office or home use. By utilizing these convenient features, you can maximize the effectiveness of this unit.

FILE

Warning:

- WHEN A FAILURE OCCURS WHICH RESULTS IN THE INTERNAL PARTS BECOMING ACCESSIBLE, DISCONNECT THE POWER SUPPLY CORD IMMEDIATELY AND RETURN THIS UNIT TO AN AUTHORIZED SERVICE CENTER.
- DISCONNECT THE TELECOM CONNECTION BEFORE DISCONNECTING THE POWER CONNECTION PRIOR TO RELOCATING THE EQUIPMENT, AND RECONNECT THE POWER FIRST.
- NO "111" OR OTHER CALLS CAN BE MADE FROM THIS DEVICE DURING A MAINS POWER FAILURE.

Notice to New Zealand users:

- The grant of a Telepermit for any item of terminal equipment indicates only that Telecom has accepted that the item complies with minimum conditions for connection to its network. It indicates no endorsement of the product by Telecom, nor does it provide any sort of warranty. Above all, it provides no assurance that any item will work correctly in all respects with another item of Telepermitted equipment of a different make or model, nor does it imply that any product is compatible with all of Telecom's network services.
- This device is equipped with pulse dialling while the Telecom standard is DTMF tone dialling. There is no guarantee that Telecom lines will always continue to support pulse dialling.
- Use of pulse dialling, when this equipment is connected to the same line as other equipment, may give rise to bell tinkle or noise and may also cause a false answer condition. Should such problems occur, the user should NOT contact Telecom Faults Service.
- This equipment shall not be set to make automatic calls to the Telecom "111" Emergency Service.
- This equipment should not be used under any circumstances which may constitute a nuisance to other Telecom customers.
- All persons using this device for recording telephone conversations shall comply with NZ law. This requires that at least one party to the conversation is to be aware that it is being recorded. In addition, the principles enumerated in the Privacy Act 1993 shall be complied with in respect to the nature of the personal information collected, the purpose of its collection, how it is to be used and what it disclosed to any other party.

Copyright:

This manual is copyrighted by Kyushu Matsushita Electric Co., Ltd. (KME) and its licensee. Under the copyright laws, this manual may not be reproduced in any form, in whole or part, without the prior written consent of KME and its licensee.

© Kyushu Matsushita Electric Co., Ltd. 1998

Important safety instructions

When using this unit, basic safety precautions should always be followed to reduce the risk of fire, electric shock, or personal injury.

1. Read and understand all instructions.
2. Follow all warnings and instructions marked on this unit.
3. Unplug this unit from AC outlets before cleaning. Do not use liquid or aerosol cleaners. Use a damp cloth for cleaning.
4. Do not use this unit near water, for example, near a bath tub, wash bowl, kitchen sink, or the like.
5. Place the unit securely on a stable surface. Serious damage and/or injury may result if the unit falls.
6. Do not cover slots and openings on the unit. They are provided for ventilation and protection against overheating. Never place the unit near radiators, or in a place where proper ventilation is not provided.
7. Use only the power source marked on the unit. If you are not sure of the type of power supplied to your home, consult your dealer or local power company.
8. For safety purposes this product is equipped with a three prong grounded plug. If you do not have this type of outlet, please have one installed. Do not use any type of adaptor plug to defeat this safety feature.
9. Do not place objects on the power cord. Install the unit where no one can step or trip on the cord.
10. Do not overload wall outlets and extension cords. This can result in the risk of fire or electric shock.
11. Never push any objects through slots in this unit. This may result in the risk of fire or electric shock. Never spill any liquid on the unit.
12. To reduce the risk of electric shock, do not disassemble this unit. Take the unit to an authorized service centre when service is required. Opening or removing covers may expose you to dangerous voltages or other risks. Incorrect reassembly can cause electric shock when the unit is subsequently used.
13. Unplug this unit from the wall outlet and refer servicing to an authorized service centre when the following conditions occur:
 - A. When the power supply cord or plug is damaged or frayed.

- B. If liquid has been spilled into the unit.
 - C. If the unit has been exposed to rain or water.
 - D. If the unit does not work normally by following the operating instructions. Adjust only controls covered by the operating instructions. Improper adjustment may require extensive work by an authorized service centre.
 - E. If the unit has been dropped or physically damaged.
 - F. If the unit exhibits a distinct change in performance.
14. During thunderstorms, avoid using telephones except cordless types. There may be a remote risk of an electric shock from lightning.
 15. Do not use this unit to report a gas leak, when in the vicinity of the leak.

SAVE THESE INSTRUCTIONS

INSTALLATION:

1. Never install telephone wiring during a lightning storm.
2. Never install telephone jacks in wet locations unless the jack is specifically designed for wet locations.
3. Never touch uninsulated telephone wires or terminals unless the telephone line has been disconnected at the network interface.
4. Use caution when installing or modifying telephone lines.



WARNING:

- To prevent the risk of fire or electrical shock, do not expose this product to rain or any type of moisture.

OTHER INFORMATION:

- Keep the unit away from electrical noise-generating devices, such as fluorescent lamps and motors.
- The unit should be kept free from dust, high temperature, and vibration.
- The unit should not be exposed to direct sunlight.
- Do not place heavy objects on top of this unit.
- Do not touch the plug with wet hands.

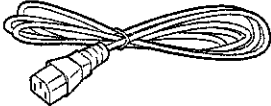
Included accessories

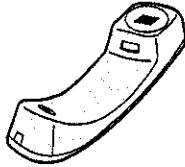
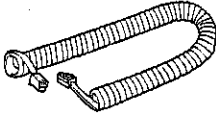
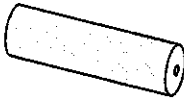
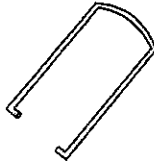
Power cord 1 pc. 	Telephone line cord 1 pc. 	Handset 1 pc. 
Handset cord 1 pc. 	Recording paper 1 pc.  — See below for ordering the recording paper.	Paper stacker..... 1 pc. 

- If any items are missing or damaged, check with the place of purchase.
- Save the original carton and packing materials for future shipping and transporting of the unit.

Accessory order information

Use the following types of recording paper for replacement.

Model No.	Description	Specifications
KX-A106	Standard thermal recording paper	216 mm x 30 m (8½" x 98') roll, with 25 mm (1") core
KX-A125	Super thermal recording paper (Like plain paper)	216 mm x 30 m (8½" x 98') roll, with 25 mm (1") core

Help function

You can print a quick reference for assistance as follows.

1 Select which operation you want to print out by pressing **HELP** repeatedly.

- Pressing **HELP** one time

1. HOW TO SET UP

two times

2. EASY DIAL

three times

3. FAX OPERATION

four times

4. RECEIVE MODE

five times

5. TAD OPERATION

2 Press **START/COPY/SET**.

PRINTING

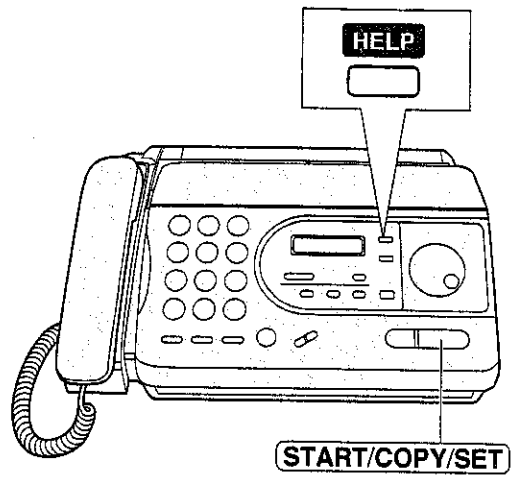

Quick Start

To install the recording paper

- 1 Open the cover by pressing the cover open button.

- 2 Install a recording paper roll.

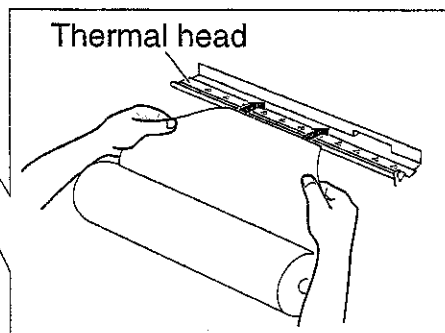
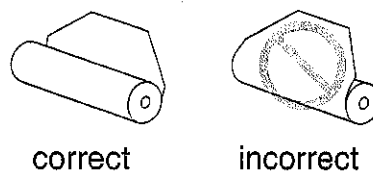
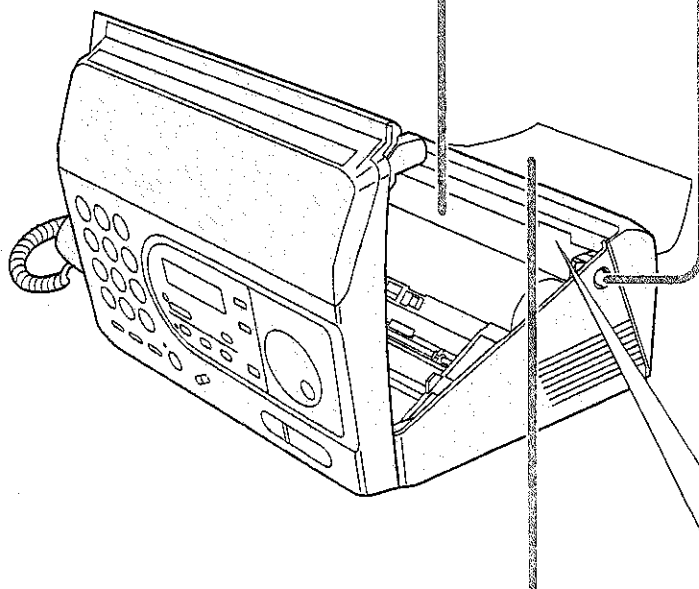

- 3 Insert the leading edge of the paper into the opening above the thermal head and pull it out of the unit.

- 4 Close the cover securely by pushing down on both corners.

- 5 Install the paper stacker.

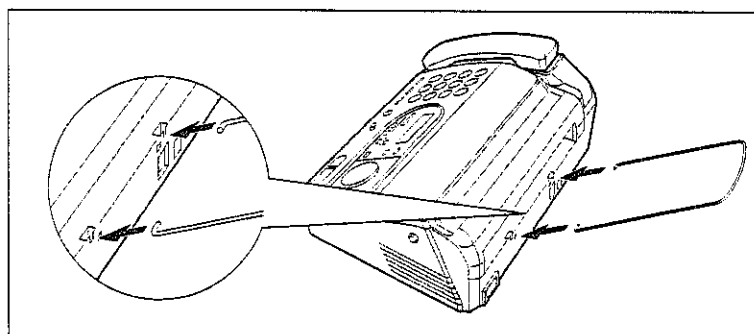

● For further details, see page 19.

To connect the unit

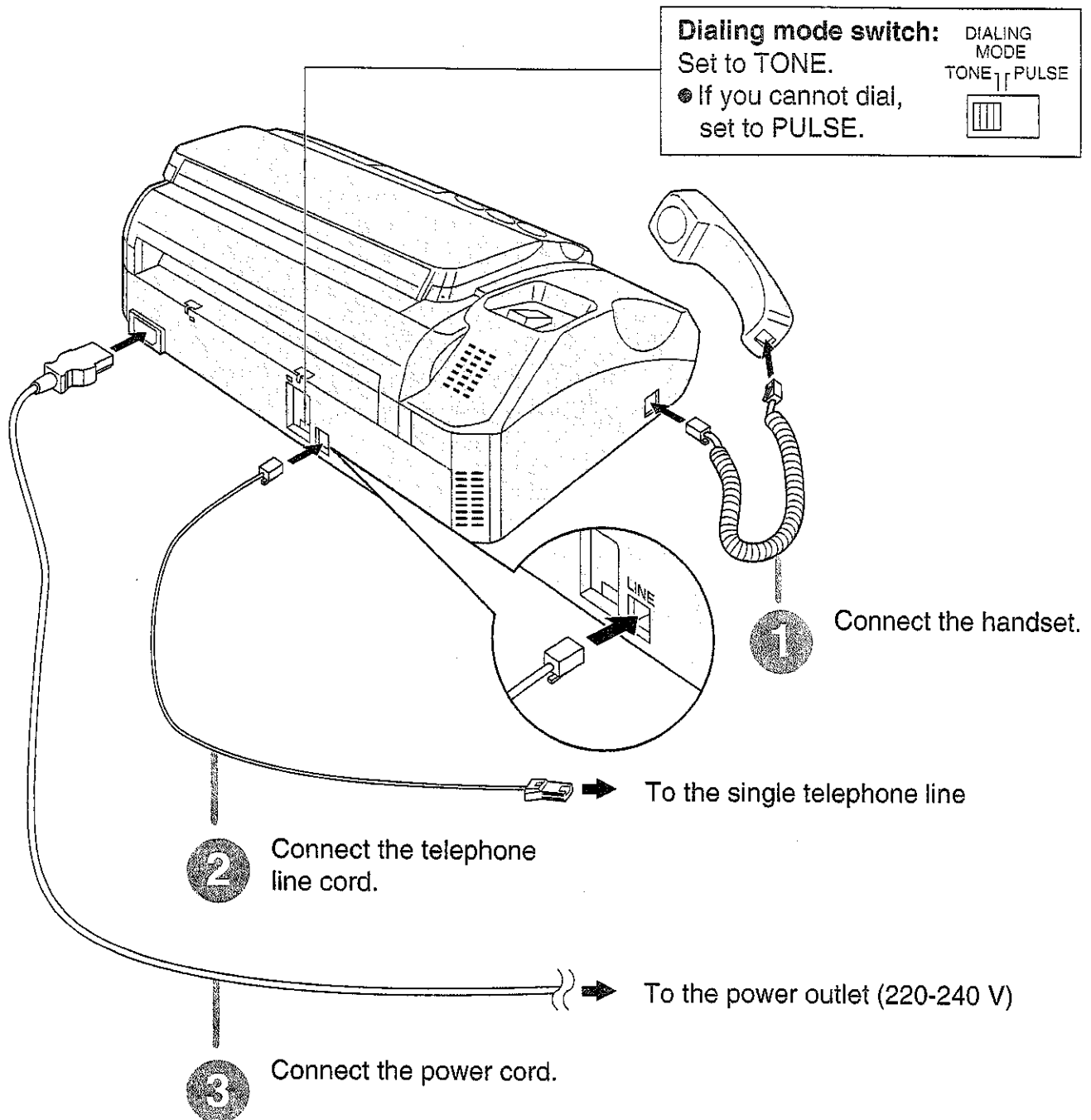

- This device is equipped with pulse dialling while the Telecom standard is DTMF tone dialling. There is no guarantee that Telecom lines will always continue to support pulse dialling.
- Use of pulse dialling, when this equipment is connected to the same line as other equipment, may give rise to bell tinkle or noise and may also cause a false answer condition. Should such problems occur, the user should NOT contact Telecom Faults Service.
- For further details, see page 20.
- You can print a quick reference for assistance (see the "Help function" on page 5).

Quick Start

To make a voice call

1 Lift the handset.

2 Dial the number.

3 When finished,
hang up the handset.

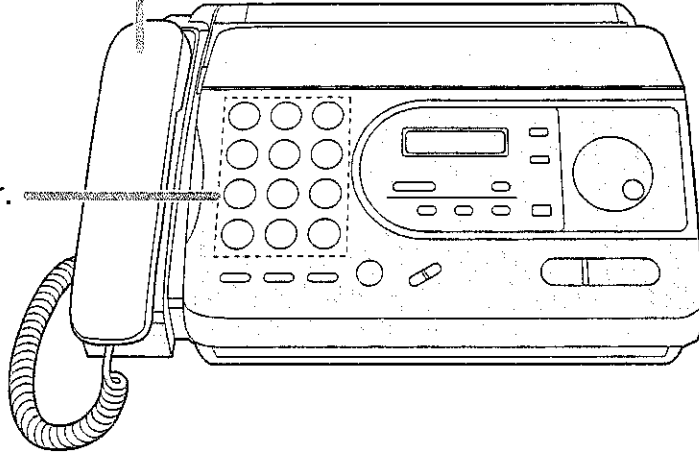

To answer a voice call

1 When the unit rings,
lift the handset.

2 When finished,
hang up the handset.

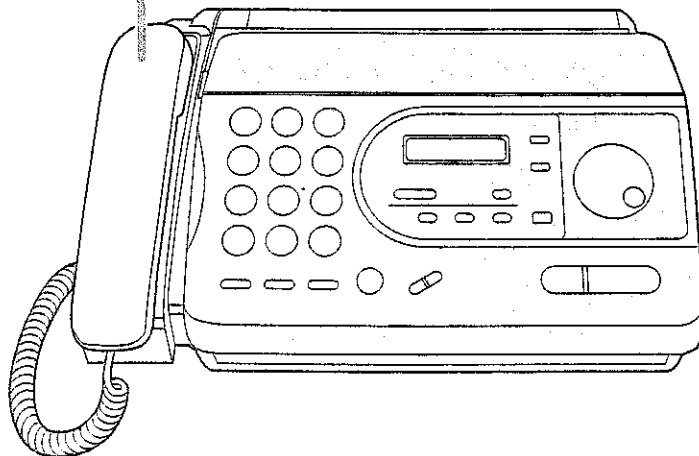

• For further details, see page 26.

To send faxes

- 1 Open the document feeder tray.

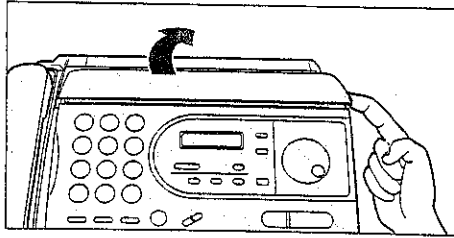

- 2 Adjust the width of the document guides to the size of the document.

- 3 Insert the document until a beep tone is heard.

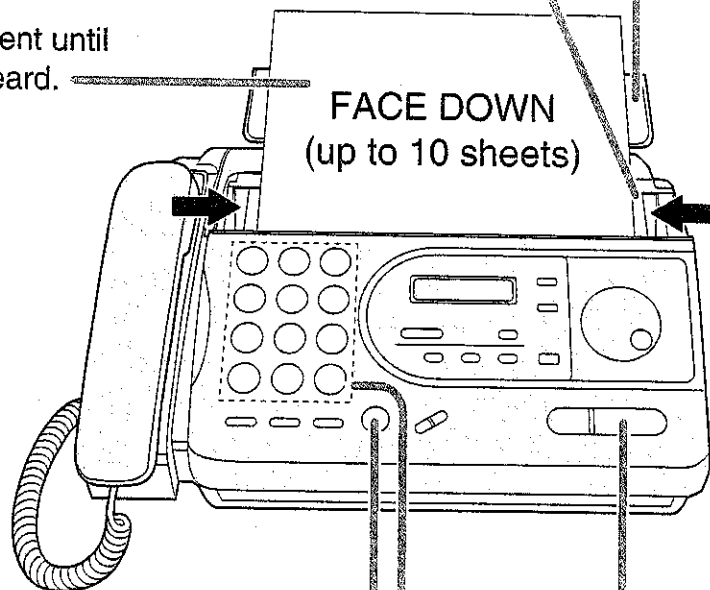

- 4 Press **DIGITAL SP-PHONE**.

- 5 Dial the fax number.

- 6 When a fax tone is heard, press **START/COPY/SET**.

● For further details, see page 33.

Quick Start

To receive faxes

- 1 When the unit rings, lift the handset.

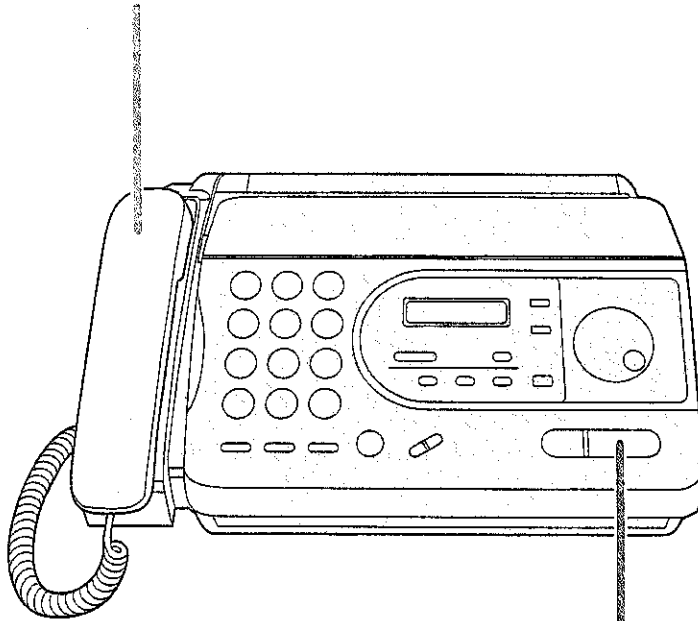

- 2 When:
—document reception is required,
—a fax calling tone (slow beep) is heard, or
—no sound is heard,
press **START/COPY/SET**.

- 3 Hang up the handset.

- For further details, see page 44.
- You can select the desired receive mode according to your needs. See pages 42 and 43.

To make a copy

- 1 Open the document feeder tray.

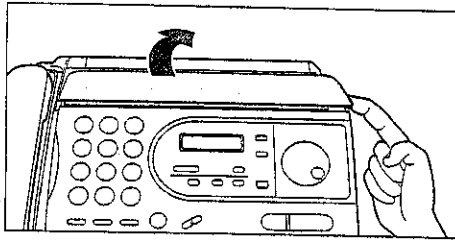

- 2 Adjust the width of the document guides to the size of the document.

- 3 Insert the document until a beep tone is heard.

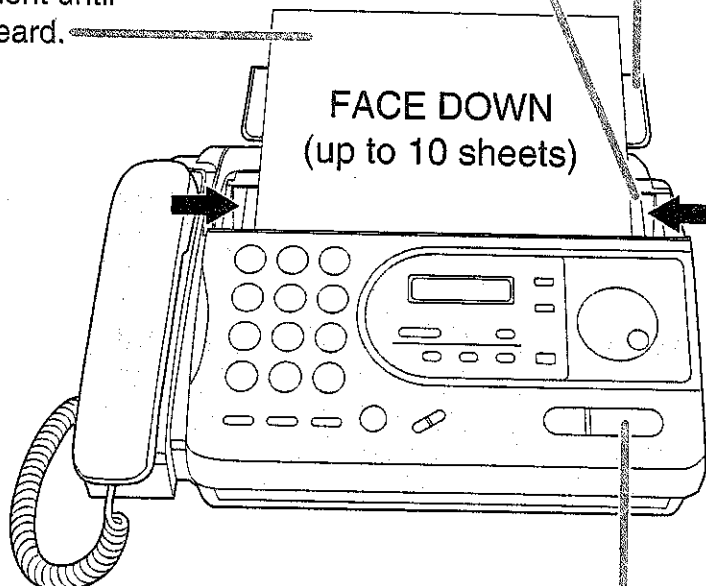

- 4 Press **START/COPY/SET**.

● For further details, see page 56.

Quick Start

Operating the answering device

Setting the unit to receive voice messages and fax messages automatically

- 1 Press **AUTO RECEIVE** until the AUTO RECEIVE light turns on.

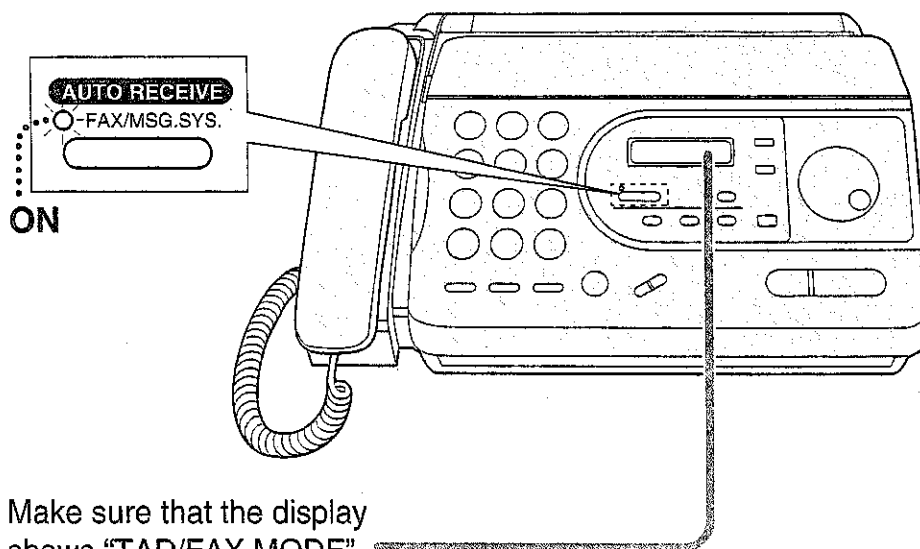

- 2 Make sure that the display shows "TAD/FAX MODE".

- If the display does not show "TAD/FAX MODE" when the AUTO RECEIVE light turns on, the setting needs to be changed to the TAD/FAX mode. See page 57.

Listening to recorded messages

- 1 Press **PLAY MESSAGES** when the PLAY MESSAGES light is flashing or on.
 - When the PLAY MESSAGES light is:
 - flashing, the unit will only play the new messages.
 - on, the unit will play all the messages.

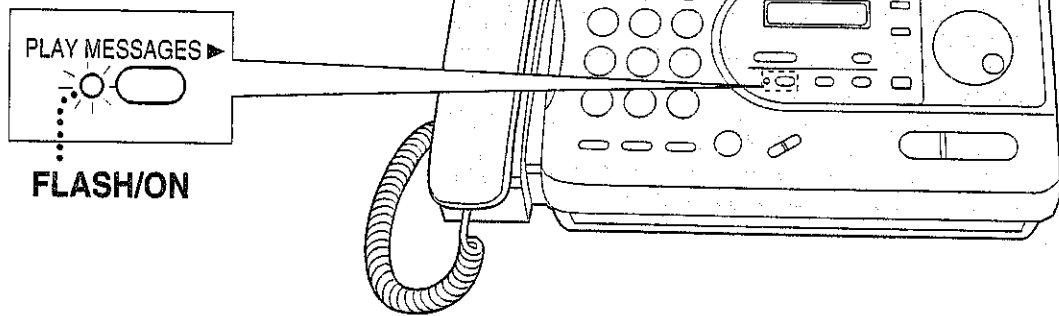

• For further details, see page 62.

Erasing recorded messages

Erasing a specific message

- 1 Press **ERASE** while listening to the message you want to erase.

Erasing all the messages

- 1 Press **ERASE** after listening to all of the messages.

- 2 Press **START/COPY/SET**.

- 3 Press **START/COPY/SET** again.

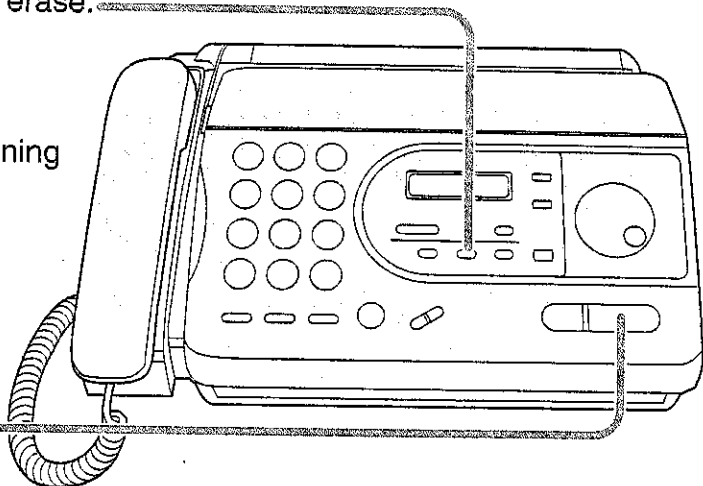

• For further details, see page 62.

Table of Contents

Initial Preparation	Finding the Controls	Location	16
		Overview	18
	Setup	Installing the recording paper	19
		Installing the paper stacker	19
		Connections	20
		Programming the date and time, your name and facsimile telephone number	21
	Volumes	Adjusting volumes	25
Telephone	Making and Answering Calls	Making a voice call manually	26
		Answering a voice call	26
		TONE, RECALL and PAUSE buttons	27
	EASY DIAL	Storing names and telephone numbers in the EASY DIAL directory	28
	Making a voice call using the EASY DIAL directory	31	
	Voice Contact	Talking to the caller after fax transmission or reception	32
Fax/Copy	Sending Faxes	Sending faxes manually	33
		Sending faxes using the EASY DIAL directory	34
		Documents you can send	35
		Sending faxes by following the voice guide	36
		Printing the transmission report	37
		Setting the journal report to print automatically	38
		Delayed transmission (sending a fax at a specific time)	39
		Transmit polling (letting another machine retrieve a fax on your unit)	40
		Sending documents overseas	40
		Connecting tone	41
	Receiving Faxes	Selecting the way to receive calls	42
		TEL mode (answering all calls manually)	44
		TEL/FAX mode (receiving voice calls with rings and fax calls without rings)	45
		FAX ONLY mode (all calls are received as faxes)	48
	Distinctive ring service (FaxAbility)	50	
	Receiving faxes using an extension telephone	52	
	Changing the fax activation code	53	
	Receive polling (retrieving faxes placed on another party's machine)	54	
	Setting the friendly reception	54	
	Signaling your pager when your unit receives a fax	55	
	Copying	Making a copy	56
Answering Device	Setup	TAD/FAX mode (using the built-in answering device and receiving voice and fax calls automatically)	57
	Greeting	Pre-recorded greeting messages	58
		Recording your own greeting messages	59
		Erasing your own recorded greeting messages	60
		Recording time for the TAD/FAX greeting message	61

Answering Device	Playing Messages	Listening to recorded messages	62
		Erasing recorded messages	62
		Functions while playing a message (repeating, skipping and stopping) . .	63
	Recording	Memo message (leaving a message for others or yourself)	64
		Telephone conversation	64
	Remote Operation	Operating from a remote location	65
		Setting the remote operation ID	66
		From a remote touch tone telephone	67
	Options	Transferring recorded messages to another phone	70
		Ring count in the TAD/FAX mode	73
		Incoming message recording time	74
		Message alert (beeps when a voice message is received)	74
		Recording time alert (beeps when memory is almost full)	75
		Setting the ICM monitor	75
Help	Error Messages	Error messages on printed reports	76
		Error messages on the LCD display	77
	Operations	When a function does not work, check here before requesting help . .	78
		If a power failure occurs	80
	Jams	Clearing a recording paper jam	81
		When a document you are sending jams	82
		When documents you send do not feed, or multi-feed	83
	Cleaning	Cleaning the document feeder	84
		Cleaning the thermal head	85
	General Information	Print Reports	Printing the feature settings, telephone numbers, and the journal . .
Fax Voice Guidance		Fax voice guidance	87
Display Contrast		Changing the LCD display contrast	88
Original Mode		Setting the original mode	88
Reset		Resetting the advanced features	89
Features Summary		Summary of user programmable features	90
Specifications		Technical data about this product	93
Index		Index	94

Initial Preparation

Telephone

Fax/Copy

Answering Device

Help

General Information

Finding the Controls

Location

- Used to change from pulse to tone during dialing (p. 27).
- Used to turn on/off the auto receive mode (p. 42, 43).
- Used as a secret key (p. 28, 29).
- Used to skip the recorded messages in answering device (p. 63).
- Used to repeat the recorded messages in answering device (p. 63).
- Used to play recorded messages (p. 62).
- Used to redial the last number dialed (p. 26, 33).
- Used to insert a pause during dialing (p. 27).
- Used for voice muting (p. 26).
- Used as a hyphen key (p. 29).
- Used for quick playback (p. 63).
- Used to adjust volumes (p. 25).
- Used to select feature settings during programming.
- Used for speakerphone operation.
- Used to erase recorded messages (p. 62).
- Used to erase your own greeting messages (p. 60).
- Used as a hookswitch (p. 27).
- Used for slow playback (p. 63).
- Used to record greeting messages (p. 59).
- Used to record memo messages and a telephone conversation (p. 64).

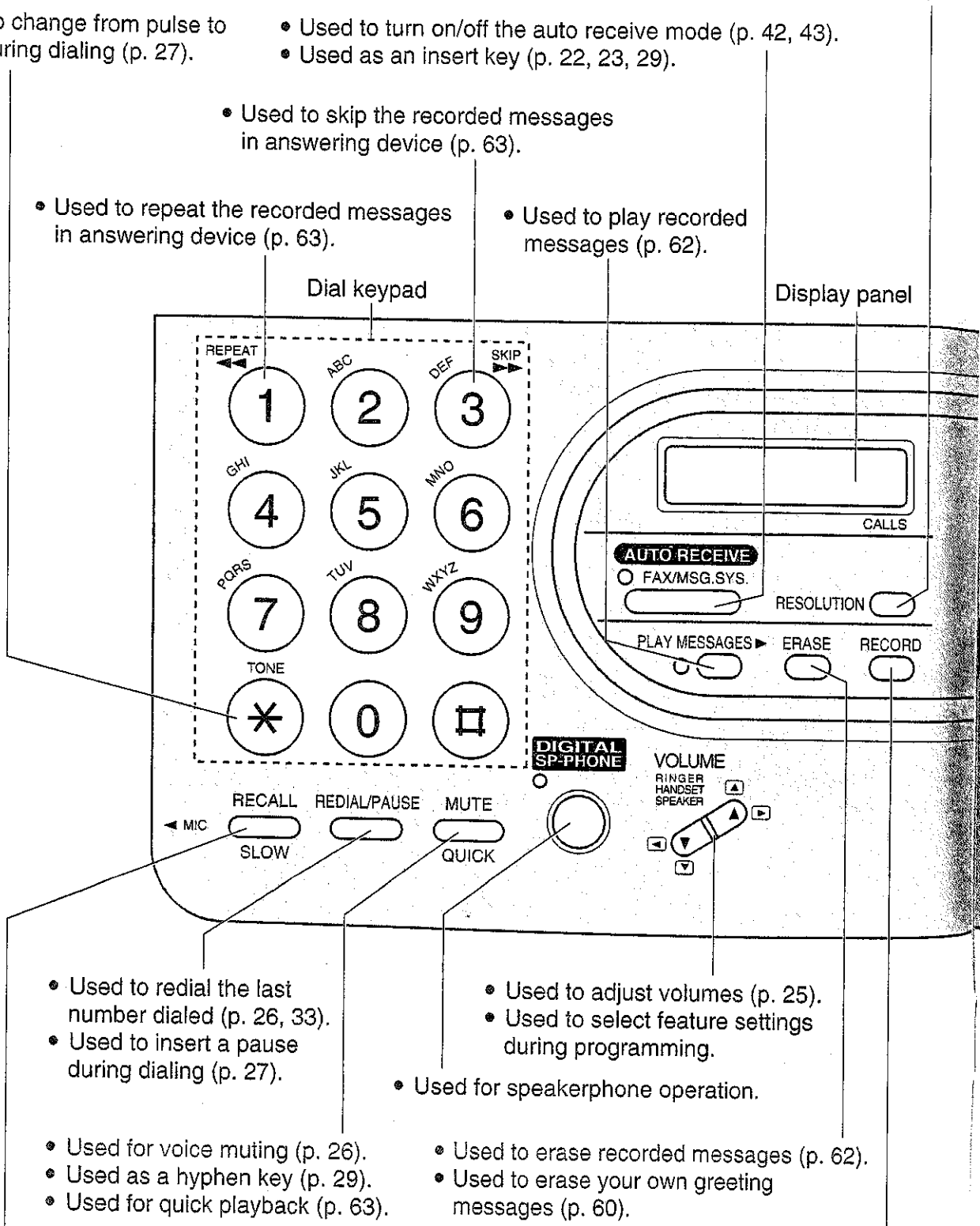

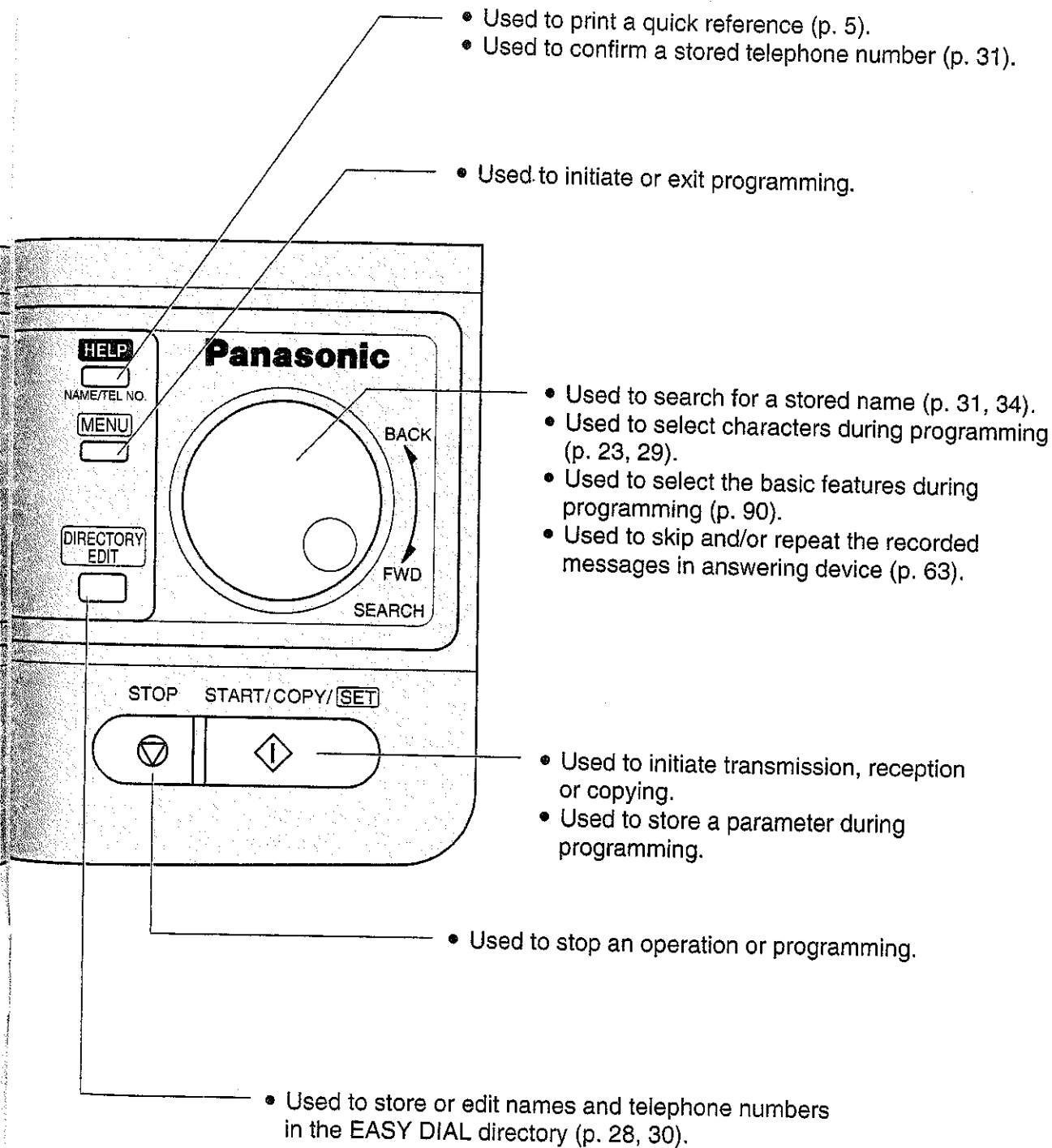

Overview

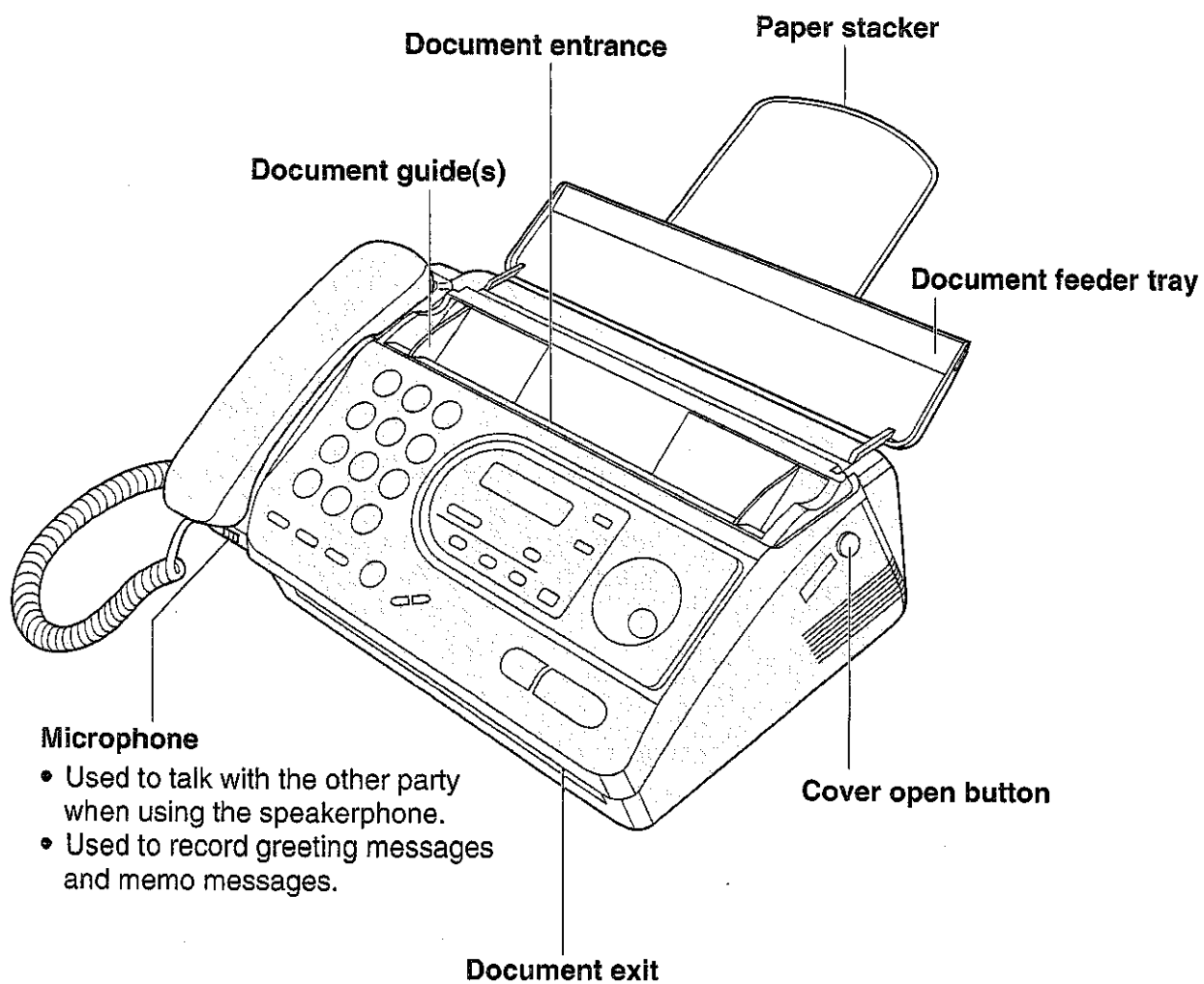

Installing the recording paper

- 1** Open the cover by pressing the cover open button and install the recording paper roll.

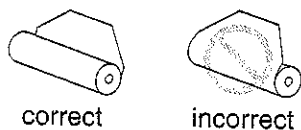

- If the paper is secured with glue or tape, cut approximately 15 cm (6 inches) from the beginning of the roll.

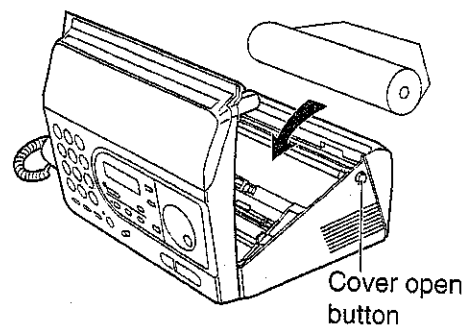

- 2** Insert the leading edge of the paper into the opening above the thermal head and pull it out of the unit.

- Make sure that there is no slack in the paper roll.

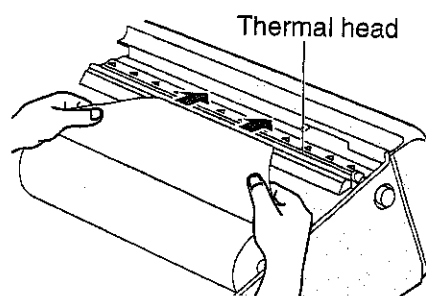

- 3** Close the cover securely by pushing down on both corners.

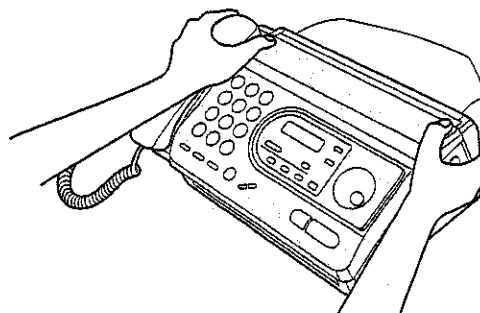

Note:

- Only use the included roll of paper or specified recording paper, or else the print quality may be affected and/or excessive thermal head wear may occur.
- To order recording paper, see page 4.
- When the power cord is connected, everytime you close the cover a message will be printed. If the recording paper is set to the wrong side, a message will not be printed. Install the paper correctly.

Installing the paper stacker

Install the paper stacker.

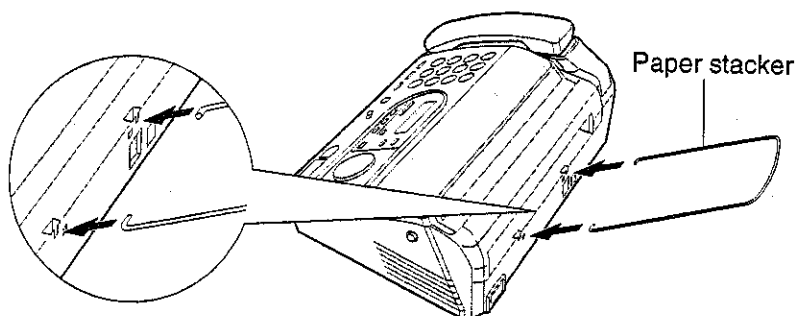

Setup

Connections

- 1 Connect the handset cord.
- 2 Connect the telephone line cord.
- 3 Connect the power cord.

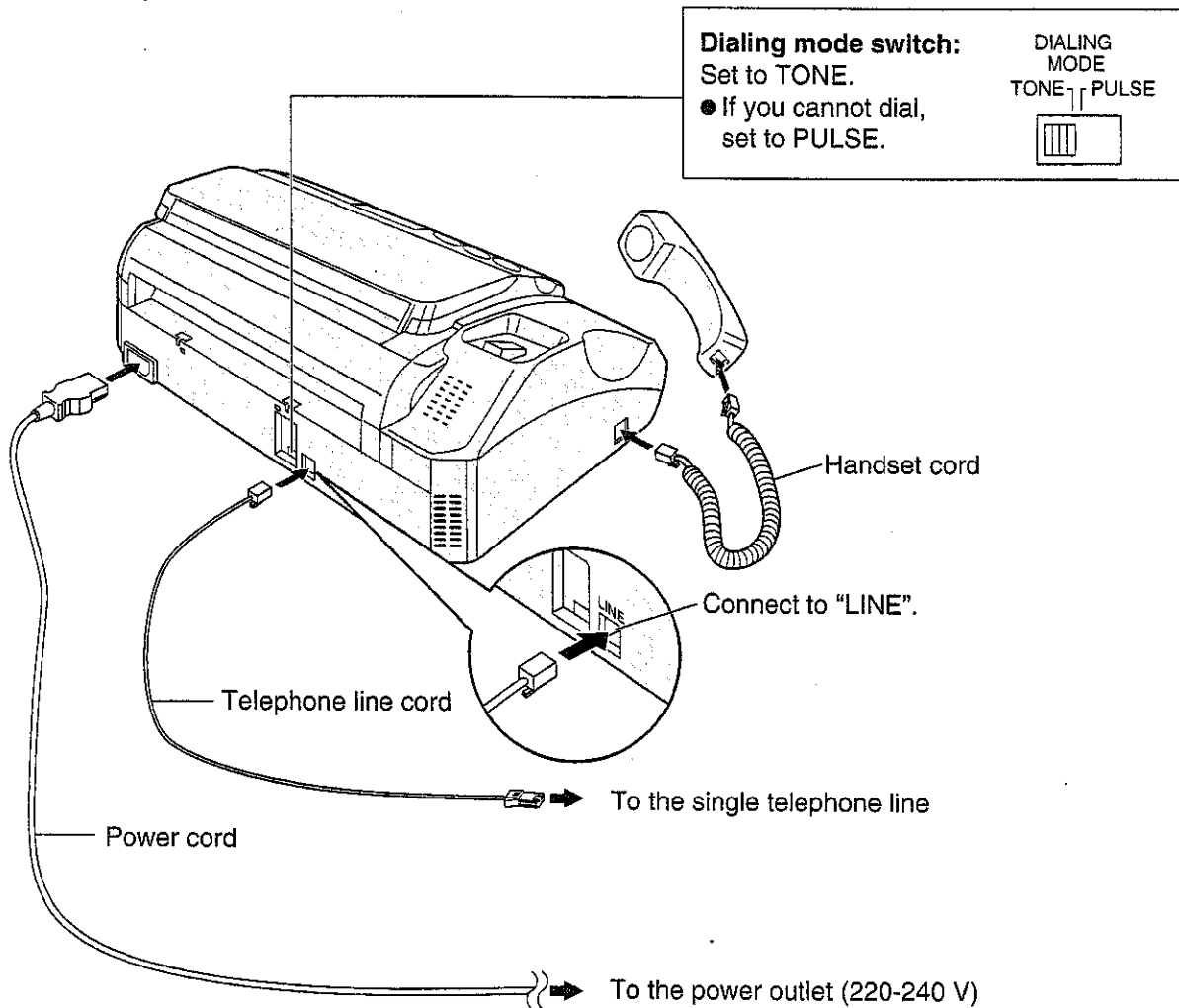

Note:

- When you operate this product, the power outlet should be near the product and easily accessible.
- This device is equipped with pulse dialling while the Telecom standard is DTMF tone dialling. There is no guarantee that Telecom lines will always continue to support pulse dialling.
- Use of pulse dialling, when this equipment is connected to the same line as other equipment, may give rise to bell tinkle or noise and may also cause a false answer condition. Should such problems occur, the user should NOT contact Telecom Faults Service.

Programming the date and time, your name and facsimile telephone number

You can program the date and time, your logo and facsimile telephone number and this information will be printed on each page transmitted from your unit.

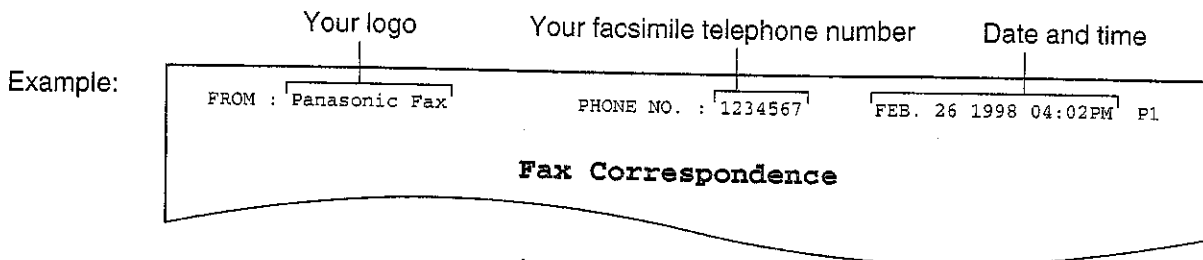

Setting the date and time

- 1 Press **MENU**.
Display: 1.SYSTEM SET UP
- 2 Press **▣**, then **0 1**.
SET DATE & TIME
- 3 Press **START/COPY/SET**.
M:01/D:01/Y:98
Cursor
- 4 Enter the correct month/day/year by selecting each 2 digits.
Example: Aug. 10, 1998
Press **08 10 98**.
M:08/D:10/Y:98
- 5 Press **START/COPY/SET**.
TIME: 12:00AM
- 6 Enter the correct hour/minute by selecting each 2 digits. Press ***** to select "AM" or "PM".
Example: 3:15PM
1. Press **03 15**.
TIME: 03:15AM
2. Press ***** until "PM" is displayed.
TIME: 03:15PM
- 7 Press **START/COPY/SET**.
SETUP ITEM []
- 8 Press **MENU**.

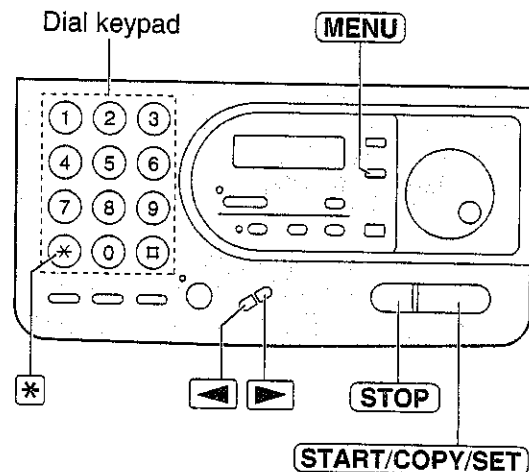

Note:

- The ***** key can be used to select "AM" or "PM" wherever the cursor is located.
- The accuracy of the clock will be approximately ± 60 seconds a month.
- This unit is year 2000 compliant.

To correct a mistake

- Press **◀** or **▶** to move the cursor to the incorrect number, then make the correction.
- If you press **STOP** while programming, the display will return to the previous one.

Setup

Setting your logo

The logo can be your company, division or personal name.

1 Press **MENU**.
Display: 1.SYSTEM SET UP

2 Press **□**, then **0 2**.
YOUR LOGO

3 Press **START/COPY/SET**.
LOGO=

4 Enter your logo, up to 30 characters, by following the instructions on the next page.

Example (using the dial keypad): Bill

1. Press **2** twice. LOGO=B
Cursor

2. Press **4** six times. LOGO=Bi

3. Press **5** six times. LOGO=Bill

4. Press **▶** to move the cursor to the next space and press **5** six times.

LOGO=Bill

5 Press **START/COPY/SET**.
SETUP ITEM []

6 Press **MENU**.

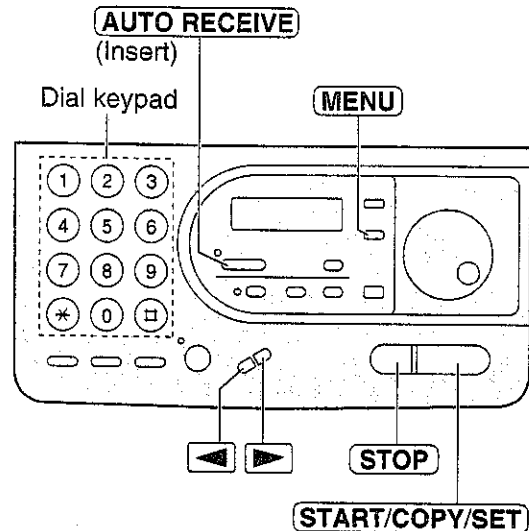

To correct a mistake

- Press **◀** or **▶** to move the cursor to the incorrect character, then make the correction.

To delete a character

- Move the cursor to the character you want to delete and press **STOP**.

To insert a character

1. Press **◀** or **▶** to move the cursor to the position to the right of where you want to insert the character.
2. Press **AUTO RECEIVE** to insert a space and enter the character.

Selecting characters with the dial keypad

Pressing the dial keys will select a character as shown below.

Keys	Characters
①	1 [] { } + - / = , . _ ` : ; ? !
②	A B C a b c 2
③	D E F d e f 3
④	G H I g h i 4
⑤	J K L j k l 5
⑥	M N O m n o 6
⑦	P Q R S p q r s 7
⑧	T U V t u v 8
⑨	W X Y Z w x y z 9
⑩	0 () < > ! " # \$ % & ¥ * @ ^ ' →
AUTO RECEIVE	Insert key (Used to insert a space.)
VOLUME ▼	◀ key (Used to move the cursor to the left.)
VOLUME ▲	▶ key (Used to move the cursor to the right.) To enter the same number key continuously, move the cursor to the next space.

Selecting characters with the EASY DIAL

Instead of pressing the dial keys, you can select characters using the EASY DIAL.

1. Rotate **EASY DIAL** until the desired character is displayed.
2. Press ▶ to move the cursor to the next space.
 - The character displayed in step 1 is inserted.
3. Return to step 1 to enter the next character.

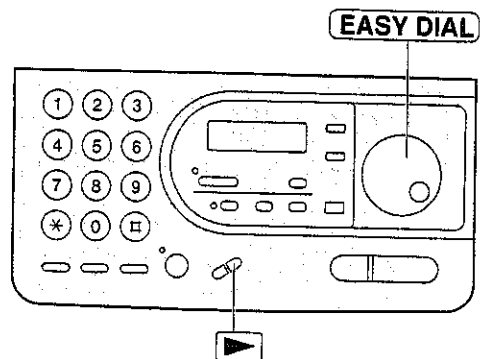

Display order of characters

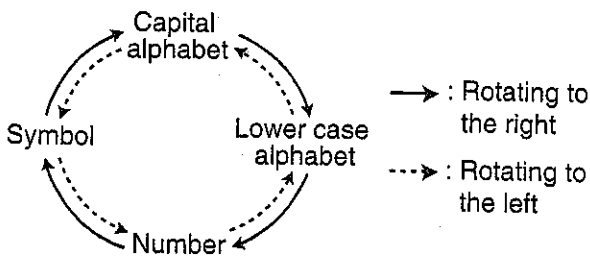

Setup

Setting your facsimile telephone number

- 1 Press **MENU**.
Display: 1.SYSTEM SET UP
- 2 Press **□**, then **0 3**.
YOUR TEL NO.
- 3 Press **START/COPY/SET**.
NO. =
- 4 Enter your facsimile telephone number up to 20 digits.
Example: NO. =1234567
- 5 Press **START/COPY/SET**.
SETUP ITEM []
- 6 Press **MENU**.

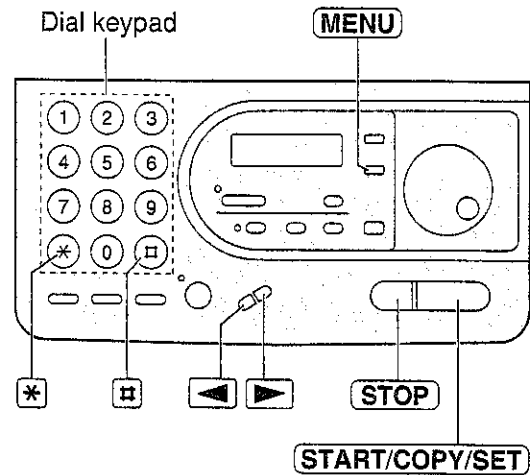

Note:

- The **□** button inserts a space and the ***** button a "+".

Example: +64 9 1234567

Press ***64□9□1234567**.

To correct a mistake



- Press **◀** or **▶** to move the cursor to the incorrect number, then make the correction.

To delete a number

- Move the cursor to the number you want to delete and press **STOP**.

Adjusting volumes

Ringer volume

4 levels (high/middle/low/off) are available.
Press  or  while the unit is idle.

■ To turn the ringer off:

1. Press  repeatedly until the following message is displayed.

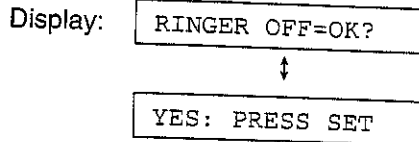

2. Press **START/COPY/SET**.

- To turn the ringer back on, press .

■ While the ringer volume is set to off:

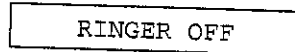

The display will flash the following message.



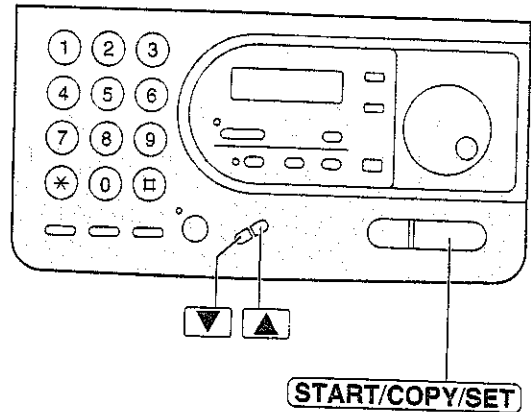
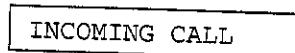

When receiving a call, the unit will not ring but will display the following.





Handset receiver volume

3 levels (high to low) are available.
Press  or  while using the handset.



Speaker volume

8 levels (high to low) are available.
Press  or  while using the speakerphone.

Fax voice guidance volume

9 levels (high to off) are available.
Press  or  while listening to the fax voice guidance.

Answering device volume

9 levels (high to off) are available.
Press  or  while listening to the recorded messages.

Making and Answering Calls

Making a voice call manually

- 1 Press **DIGITAL SP-PHONE** or lift the handset.

Display:

- 2 Dial the telephone number.

Example:

- If you misdial, hang up and dial again.

- 3 When the other party answers, speak into the microphone or handset.

- 4 When finished, press **DIGITAL SP-PHONE** or hang up the handset.

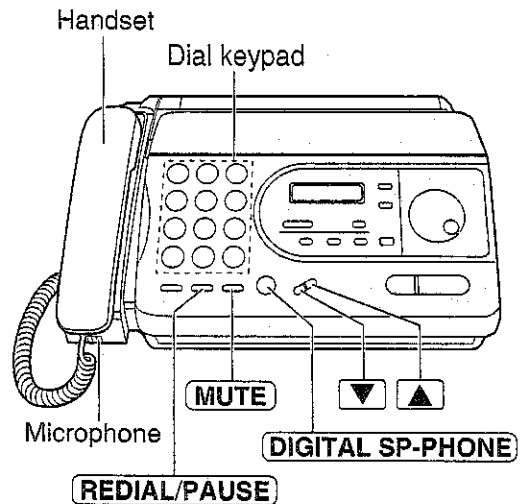

To redial the last number

1. Press **DIGITAL SP-PHONE** or lift the handset.

2. Press **REDIAL/PAUSE**.

- If the line is busy when using the **DIGITAL SP-PHONE** button, the unit will automatically redial the number up to 2 times.
- While waiting for redial, the following will be displayed.

Answering a voice call

- 1 When the unit rings, press **DIGITAL SP-PHONE** or lift the handset.

- 2 When finished, press **DIGITAL SP-PHONE** or hang up the handset.

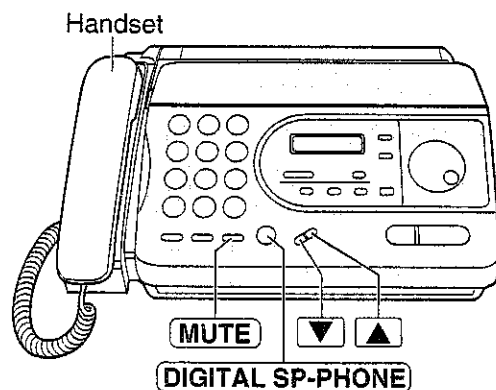

Muting your voice to the other party

1. Press **MUTE** during a telephone conversation.

Display:

- The other party cannot hear you, but you can hear them.
2. To resume the conversation, press **MUTE**.

Hints for the speakerphone operation

- Use the speakerphone in a quiet room.
- If you have difficulty hearing the other party, adjust the volume using **▼** or **▲**.
- If you and the other party speak at the same time, parts of your conversation will be cut off.
- To switch to the handset, lift the handset. To switch back to the speakerphone, press **DIGITAL SP-PHONE**.

TONE, RECALL and PAUSE buttons

TONE button

The **TONE** (*) button is used for rotary pulse dial services and allows you to temporarily change from the pulse to tone mode during a dialing operation. When you hang up, the unit will automatically return to the pulse mode.

RECALL button

The **RECALL** button functions as the hookswitch on a regular telephone. If you misdial a telephone number, press the **RECALL** button firmly.

The **RECALL** button also allows you to use special features of a host exchange (if connected) or local telephone company services such as call waiting. For further details, contact your host exchange supplier or local telephone company.

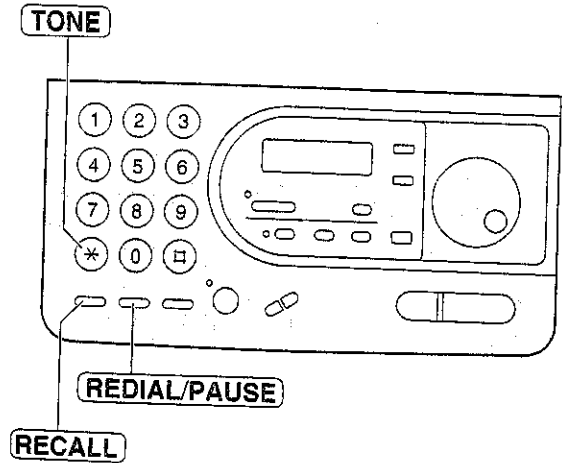

Note:

- TONE, RECALL and PAUSE can be stored into a telephone number in the EASY DIAL directory.

Entering pauses

When the **REDIAL/PAUSE** button is pressed during dialing, a pause will be inserted.

Example 1:

When your unit is connected to a host exchange, insert a pause before the telephone number to get an outside line.

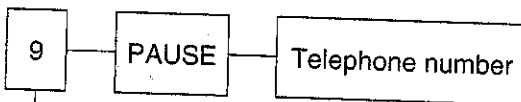

Line access code

Example 2:

If a transmission error occurs during an overseas transmission, add two pauses at the end of the telephone number.

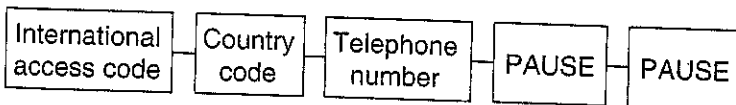

Telephone

EASY DIAL

Storing names and telephone numbers in the EASY DIAL directory

You can store up to 100 names and telephone numbers for rapid access to frequently dialed numbers.

- 1** Press **DIRECTORY EDIT**.
The number of entries available in the directory

Display: **SPACE=100 DIRS.**
↓
NAME=

- 2** Enter the name, up to 10 characters, by following the instructions on the next page.

Example: **NAME=Alice**

- 3** Press **START/COPY/SET**.

NO.=

- 4** Enter the telephone number up to 30 digits.

Example: **NO.=5552233**

- 5** Press **START/COPY/SET**.

REGISTERED
↓
NAME=

- To program other items, repeat steps 2 to 5.

- 6** Press **STOP** to exit the program.

Note:

- To confirm the stored names and telephone numbers, print a telephone number list (see page 86).
- You can store items during a telephone conversation.
- After 95 items are stored, the following message will be displayed in step 5.

SPACE= 5 DIRS.

- By rotating **EASY DIAL** to the right, stored items can be displayed. The order is as follows: alphabet, number, symbol and telephone number (when a name is not stored).

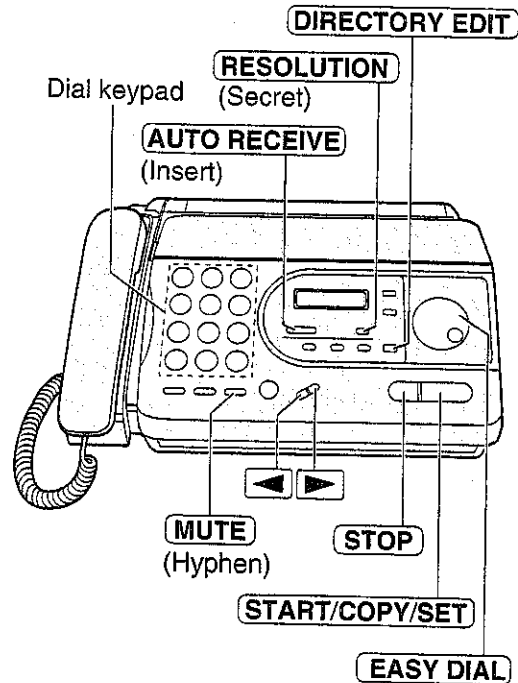

To correct a mistake

- Press **◀** or **▶** to move the cursor to the incorrect character, then make the correction.

To delete a character

- Move the cursor to the character you want to delete and press **STOP**.

To keep the telephone number secret

Press **RESOLUTION** after entering the telephone number in step 4.

- The telephone number will not appear on the telephone number list.
- Pressing **RESOLUTION** does not count as a digit.

Selecting characters with the dial keypad

Pressing the dial keys will select a character as shown below.

Keys	Characters
①	1 [] { } + - / = , . _ ` : ; ?
②	A B C a b c 2
③	D E F d e f 3
④	G H I g h i 4
⑤	J K L j k l 5
⑥	M N O m n o 6
⑦	P Q R S p q r s 7
⑧	T U V t u v 8
⑨	W X Y Z w x y z 9
⑩	0 () < > ! " # \$ % & ¥ * @ ^ ' →
AUTO RECEIVE	Insert key (Used to insert a space.)
MUTE	Hyphen key (Used to insert a hyphen in the telephone number.)
RESOLUTION	Secret key (Used to keep the telephone number secret.)
VOLUME ▼	◀ key (Used to move the cursor to the left.)
VOLUME ▲	▶ key (Used to move the cursor to the right.) To enter the same number key continuously, move the cursor to the next space.

Note:

- A hyphen or a space entered in a telephone number is counted as two digits.

Selecting characters with the EASY DIAL

Instead of pressing the dial keys, you can select characters using the EASY DIAL.

1. Rotate **EASY DIAL** until the desired character is displayed.
2. Press ▶ to move the cursor to the next space.
 - The character displayed in step 1 is inserted.
3. Return to the step 1 to enter the next character.

Display order of characters

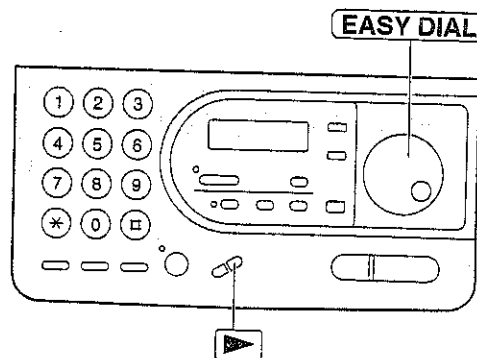
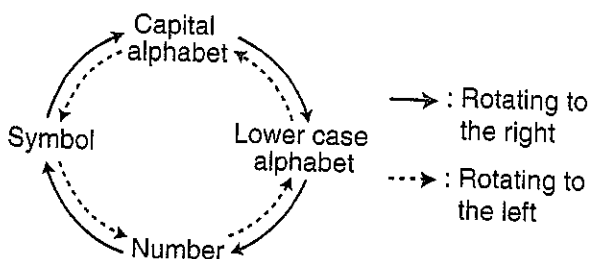

Telephone

EASY DIAL

Editing a stored name and number

- 1 Rotate **EASY DIAL** until the desired name is displayed.
Example:
- 2 Press **DIRECTORY EDIT**.
- 3 Press ***** to select "EDIT".
 - If you do not need to edit the name, skip to step 5.
- 4 Edit the name by following the instructions on page 29.
- 5 Press **START/COPY/SET**.
Example:
 - If you do not need to edit the telephone number, skip to step 7.
- 6 Edit the telephone number. For further details, see page 28.
- 7 Press **START/COPY/SET**.

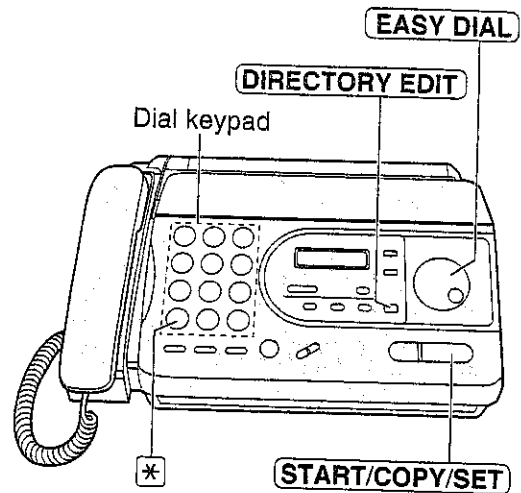

Erasing a stored name and number

- 1 Rotate **EASY DIAL** until the desired name is displayed.
Example:
- 2 Press **DIRECTORY EDIT**.
- 3 Press **#** to select "DELETE".

↓
 - If you do not want to erase the item, press **STOP**.
- 4 Press **START/COPY/SET**.
 - The stored name and number are deleted.

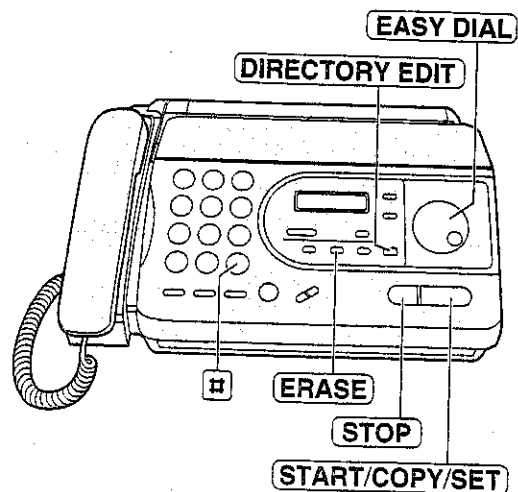

Note:

- You can use the ERASE key to erase a name and number. Press **ERASE** after rotating **EASY DIAL** in step 1, then press **START/COPY/SET**.

Making a voice call using the EASY DIAL directory

- 1** Rotate **EASY DIAL** until the desired name is displayed.

Example:

- 2** Press **DIGITAL SP-PHONE** or lift the handset.
- The unit will start dialing automatically.

- 3** When the other party answers, speak into the microphone or handset.

- 4** When finished, press **DIGITAL SP-PHONE** or hang up the handset.

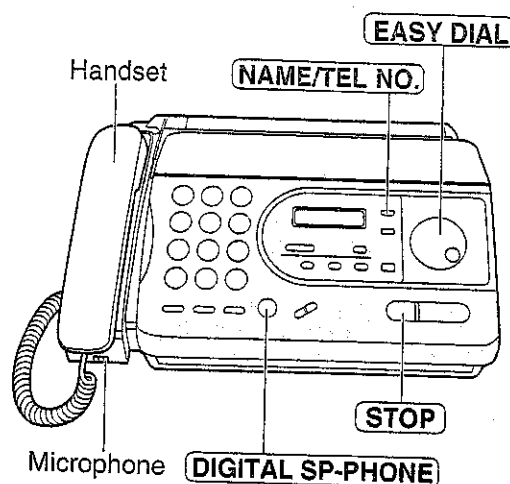

Telephone

Note:

- If the desired name has not been stored, press **STOP** and dial the number manually. To store the name and number, see page 28.

Searching for a name by the initial

Example: When you want to search for the name "Lisa"

- 1.** Rotate **EASY DIAL** until any name is displayed.

Example:

- 2.** Press **5** repeatedly until any name with the initial "L" is displayed (see the character table on page 29).

- 3.** Rotate **EASY DIAL** to the right until "Lisa" is displayed.

- To stop the operation, press **STOP**.

- 4.** Press **DIGITAL SP-PHONE** or lift the handset, and the unit will automatically dial the number.

Note:

- When you want to search for symbols (not alphabet or numbers), press the ***** key in step 2.

Confirming a stored telephone number

- 1.** Rotate **EASY DIAL** until the desired name is displayed.

Example:

- 2.** Press **NAME/TEL NO.**

- To stop the operation, press **STOP**.

- 3.** Press **DIGITAL SP-PHONE** or lift the handset, and the unit will automatically dial the number.

Voice Contact

Talking to the caller after fax transmission or reception

You can have a conversation with the same call after a fax message is completed. This will save the added expense and time of making another call.

This feature only works when the other party's unit is equipped with a voice contact feature.

Initiating voice contact

- 1 Press **DIGITAL SP-PHONE** while transmitting or receiving documents.

Display: **VOICE STANDBY**

- Your unit will call the other party with a distinctive ring.
- When the other party answers, your unit will emit a distinctive ring.

- 2 Press **DIGITAL SP-PHONE** or lift the handset to start talking.

Note:

- If you initiate voice contact during transmission, the unit will call you with a distinctive ring after all of the documents have been transmitted.
- If you initiate voice contact during reception, the unit will call you with a distinctive ring after the current page of the document is received.

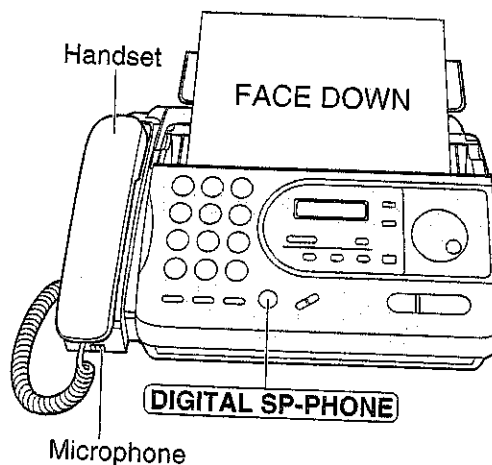

Receiving a request for voice contact

- 1 If the other party initiates voice contact, your unit will sound a distinctive ring and the following will be displayed.

Display: **PLEASE PICK UP**

- 2 Press **DIGITAL SP-PHONE** or lift the handset within 10 seconds of the distinctive ring to start talking.

Note:

- If you do not answer within 10 seconds of the distinctive ring;
 - in the TAD/FAX mode, your unit will play a greeting message and record an incoming voice message.
 - in the FAX ONLY, TEL or TEL/FAX mode, the line will be disconnected.

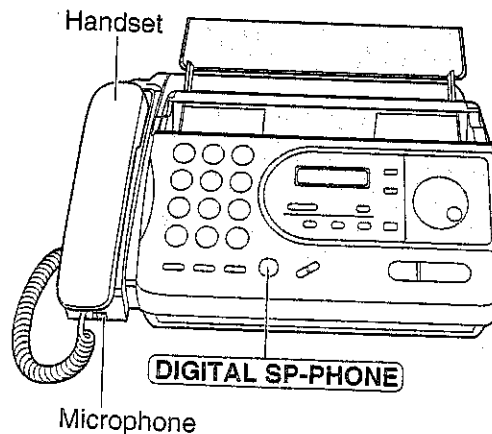

Sending faxes manually

- 1 Open the document feeder tray.
- 2 Adjust the width of the document guides to the size of the document.
- 3 Insert the document FACE DOWN (up to 10 sheets) until a beep tone is heard.

Display: STANDARD

- 4 Press **RESOLUTION** repeatedly to select the desired setting, if necessary (see the bottom of this page).

- 5 Press **DIGITAL SP-PHONE** or lift the handset.

TEL=

- 6 Dial the fax number.

Example: TEL=5678901

- 7 When a fax tone is heard, press **START/COPY/SET**, and hang up the handset if using it.

CONNECTING

Note:

- If the other party answers your call, ask them to start receiving a fax, then press your **START/COPY/SET**.

To feed 11 or more sheets at a time

Insert the first 10 sheets of the document. Add the extra sheets (up to 10) before the last sheet is fed into the unit.

Selecting the resolution

Select the desired resolution according to the type of document.

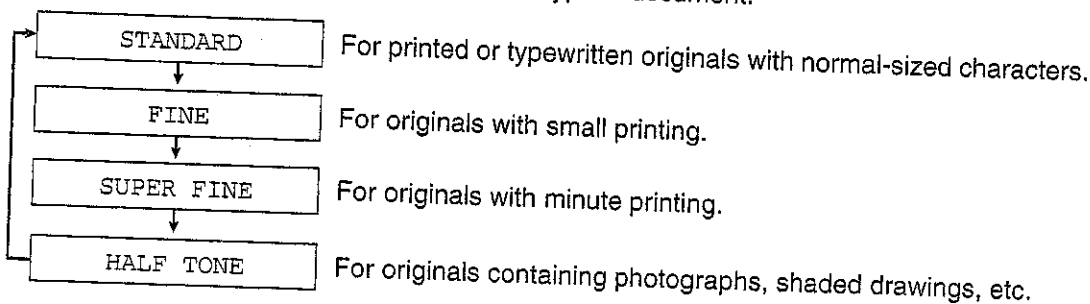

- Using the fine, super fine or half tone setting will increase the transmission time.
- If the resolution setting is changed during feeding, it will be effective from the next sheet.
- The super fine resolution only works with other compatible machines.

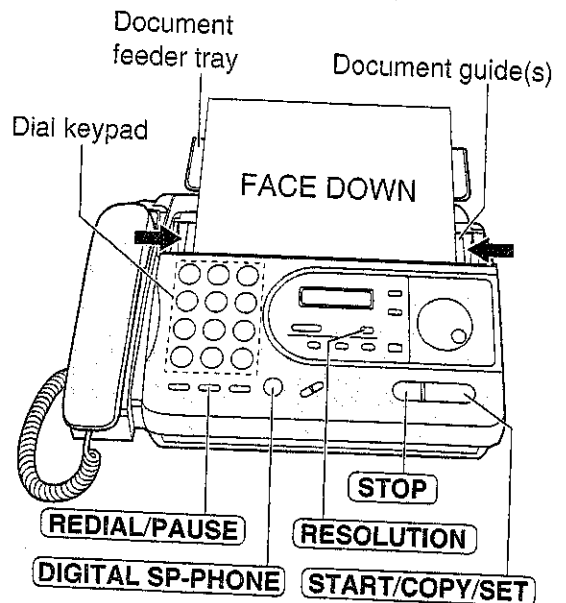

To redial the last number

Press **REDIAL/PAUSE**.

- If the line is busy, the unit will automatically redial the number up to 2 times.
- While waiting for redial, the following will be displayed.

WAITING REDIAL

To stop transmission

Press **STOP**.

To eject the document, press **STOP** again.

Sending Faxes

Sending faxes using the EASY DIAL directory

Before using this feature, program the desired names and telephone numbers into the directory (see page 28). To confirm the items stored in the directory, print a telephone number list (see page 86).

- 1 Open the document feeder tray.
- 2 Adjust the width of the document guides to the size of the document.
- 3 Insert the document FACE DOWN (up to 10 sheets) until a beep tone is heard.

Display:

- 4 Press **RESOLUTION** repeatedly to select the desired setting, if necessary (see the bottom of page 33).

- 5 Rotate **EASY DIAL** until the desired name is displayed.

Example:

- 6 Press **START/COPY/SET**.

Example:

↓

- The unit will start transmission.

Note:

- If the desired name has not been stored, press **STOP** and dial the number manually. To store the name, see page 28.
- For further details about using the EASY DIAL, see page 31.

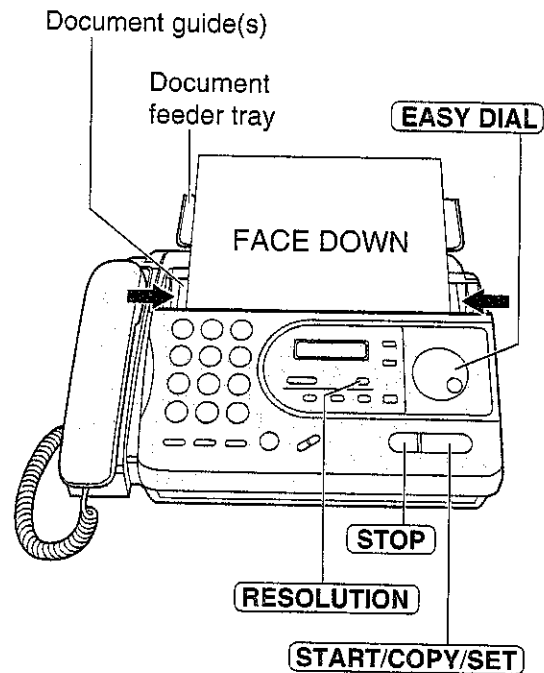

Fax auto redial

If the line is busy or there is no answer, the unit will automatically redial the number up to 2 times.

- This feature is also available for;
 - delayed transmission (page 39)
 - receive polling (page 54)
- While waiting for redial, the following will be displayed.

Display:

- To cancel redialing, press **STOP**.

Documents you can send

Minimum size

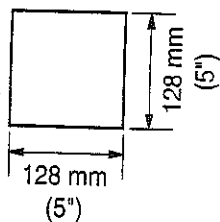

Maximum size

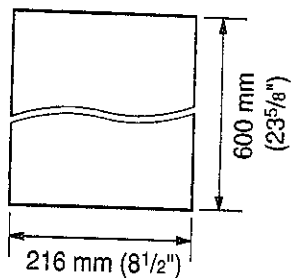

Effective scanning area

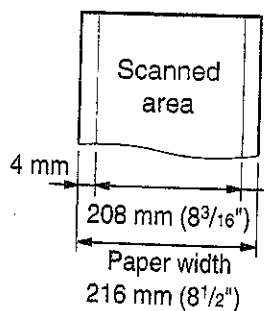

Document weight

Single sheet:
45 to 90 g/m² (12 to 24 lb.)

Multiple sheets:
60 to 75 g/m² (16 to 20 lb.)

Note:

- Remove clips, staples or other similar fastening objects.
- Check that ink, paste or correction fluid has dried.
- Do not send the following types of documents. Use copies for fax transmission.
 - Chemically treated paper such as carbon or carbonless duplicating paper
 - Electrostatically charged paper
 - Heavily curled, creased or torn paper
 - Paper with a coated surface
 - Paper with a faint image
 - Paper with printing on the opposite side that can be seen through the front (e.g. newspaper)

Sending Faxes

Sending faxes by following the voice guide

You can send the documents by following the voice guide. After transmission, the voice guide will turn off automatically.

- 1** Before inserting the document, press **MENU** four times.

Display: 4 . SEND GUIDE

- 2** Press **HELP**.

Voice guide:

To transmit, insert the document face down until you hear the beep.

- 3** Insert the document **FACE DOWN** until a beep tone is heard.

Voice guide:

Press the speaker phone button, then dial the phone number. When the fax tone is heard, press the start button.

- 4** Press **DIGITAL SP-PHONE**.

- 5** Dial the fax number.

- 6** When a fax tone is heard, press **START/COPY/SET**.

Voice guide:

Start transmission.

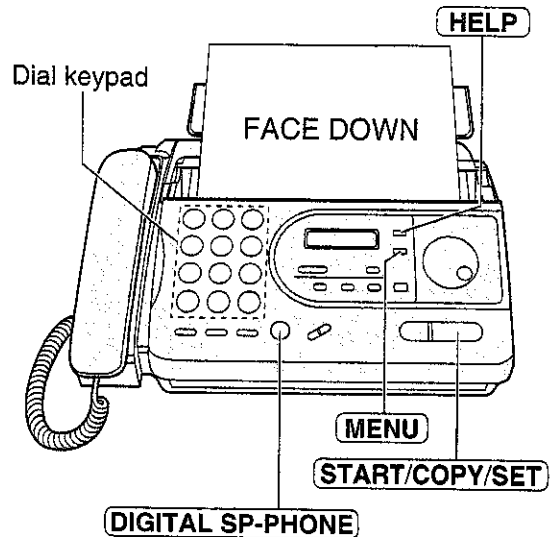

Note:

- You can lift the handset instead of pressing **DIGITAL SP-PHONE** in step 4.

Printing the transmission report

The transmission report will provide you with a printed record of the fax transmission result. One of the following choices is available.

- ERROR:** The transmission report will print out only when fax transmission fails (pre-selected setting).
- ON:** The transmission report will always print out, indicating whether fax transmission is successful or not.
- OFF:** The transmission report will not print.

- 1 Press **MENU**.
Display: 1.SYSTEM SET UP
- 2 Press **☐**, then **0 4**.
TX-REPORT MODE
- 3 Press **START/COPY/SET**.
MODE=ERROR ▼▲
- 4 Press ▼ or ▲ to select the desired setting.
- 5 Press **START/COPY/SET**.
SETUP ITEM []
- 6 Press **MENU**.

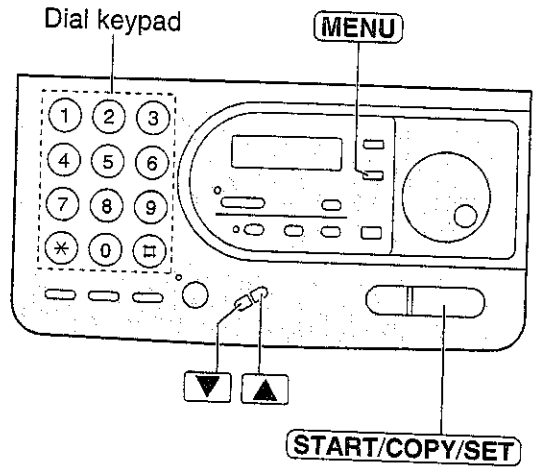

Fax/Copy

Sample of a transmission report

[TRANSMISSION REPORT]						
JAN. 20 1998 01:19PM						
NO.	OTHER FACSIMILE	START TIME	USAGE TIME	MODE	PAGES	RESULT
01	2345678	JAN. 20 01:18PM	00'51	SND	00	COMMUNICATION ERROR (65)

Communication message
(See page 76.)

Error code (for service personnel use only)

Setting the journal report to print automatically

This feature prints a journal report automatically after every 35 new fax communications. After printing, only the oldest communication result will be erased when a new communication occurs. When this feature is deactivated, the unit will store the records of the fax communications, but will not print the journal report automatically.

- 1 Press **MENU**.
Display: 1.SYSTEM SET UP
- 2 Press **□**, then **2 2**.
AUTO JOURNAL
- 3 Press **START/COPY/SET**.
MODE=ON ▼▲
- 4 Press ▼ or ▲ to select the desired setting.
• If this feature is not required, select "OFF".
- 5 Press **START/COPY/SET**.
SETUP ITEM []
- 6 Press **MENU**.

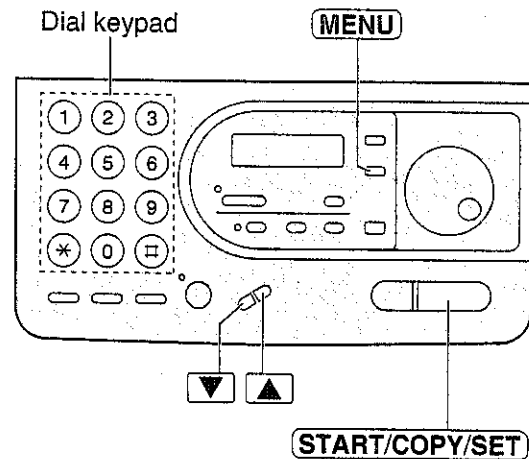

Sample of a journal report

【 JOURNAL 】							
JAN. 25 1998 05:22PM							
NO.	OTHER FACSIMILE	START TIME	USAGE TIME	MODE	PAGES	RESULT	*CODE
01	3332222	JAN. 21 02:14PM	00'45	SND	01	OK	
02	9998765	JAN. 21 03:17PM	00'58	SND	02	OK	
03	2121444	JAN. 21 05:18PM	00'48	RCV	01	OK	
04	555556677	JAN. 22 10:35AM	02'45	SND	03	COMMUNICATION ERROR	(65)
			03'50	SND	05	OK	
				RCV	03	OK	

Communication message
(See page 76.)

Error code (for service personnel use only)

Delayed transmission

(sending a fax at a specific time)

Using a built-in clock, this unit can send documents automatically at a specific time. This allows you to take advantage of low-cost calling hours offered by your telephone company. The delayed transmission can be reserved to take place up to 24 hours in advance.

1 Insert the document FACE DOWN.

Display: STANDARD

2 Press **MENU**.

1. SYSTEM SET UP

3 Press **□**, then **2 5**.

DELAYED SEND

4 Press **START/COPY/SET**.

MODE=OFF ▼▲

5 Press ▼ or ▲ to select "ON".

MODE=ON ▼▲

• If this feature is not required, select "OFF".

6 Press **START/COPY/SET**.

NO. =

7 Enter the fax number.

8 Press **START/COPY/SET**.

TIME=12:00AM

9 Enter the transmission start time.

Example: 11:30PM

Press **1 1 3 0**, then press ***** to select PM (or AM).

TIME=11:30PM

10 Press **START/COPY/SET**.

SETUP ITEM []

11 Press **MENU**.

SEND AT 11:30PM

• When the programmed time has come, the unit will automatically start transmission.

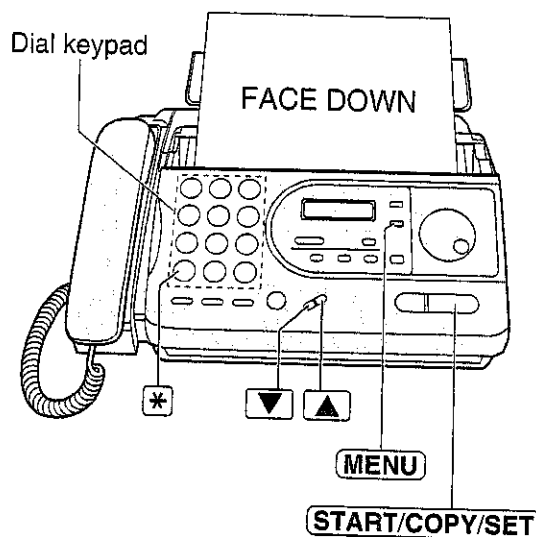

Fax/Copy

Note:

- You can receive, transmit and copy documents while delayed transmission is set.
- When transmit polling (see page 40) is set to "ON", delayed transmission is not available.
- You cannot use the EASY DIAL directory to enter the fax number for this feature.

Transmit polling (letting another machine retrieve a fax on your unit)

This feature allows another person to call your unit to retrieve a document loaded on your unit. This saves you the call charges. This feature will not work when the unit is set to the TEL mode.

- 1 Insert the document FACE DOWN.
 Display: STANDARD
- 2 Press **MENU** four times.
4. POLLED
 ↓
YES: PRESS SET
- 3 Press **START/COPY/SET**.
MODE=OFF ▼▲
- 4 Press ▼ or ▲ to select "ON".
MODE=ON ▼▲
- If this feature is not required, select "OFF".
- 5 Press **START/COPY/SET**.
POLLED ON

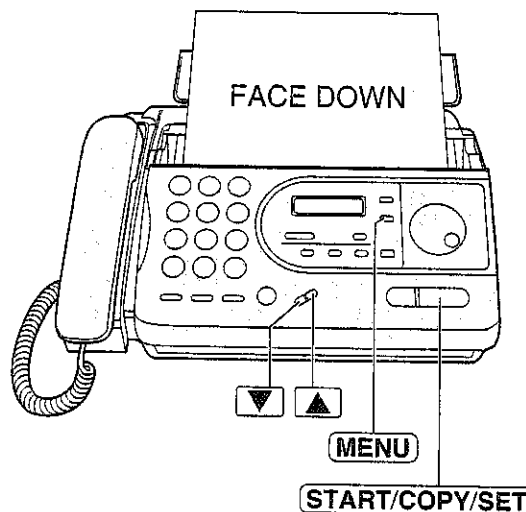

Note:

- The caller pays for the document transmission.
- When delayed transmission (see page 39) is set to "ON", transmit polling is not available.

Sending documents overseas

You may experience difficulty when transmitting documents overseas. This feature makes sending documents easier as the transmission speed is slowed down. Before starting transmission, follow the steps below.

- 1 Press **MENU**.
 Display: 1. SYSTEM SET UP
- 2 Press **□**, then **2** **3**.
OVERSEAS MODE
- 3 Press **START/COPY/SET**.
MODE=OFF ▼▲
- 4 Press ▼ or ▲ to select "ON".
MODE=ON ▼▲
- If this feature is not required, select "OFF".
- 5 Press **START/COPY/SET**.
SETUP ITEM []

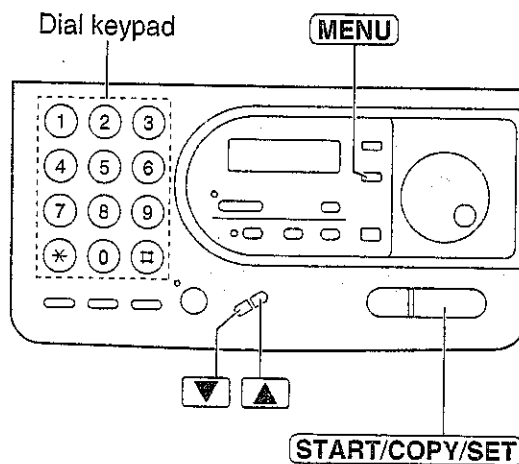

Note:

- After transmission, this feature will turn off automatically.

Connecting tone

This feature allows you to hear connecting tones, such as a fax tone, ring back tone or busy tone for several seconds when you send a fax using the EASY DIAL directory. This will tell you the status of the other party's machine.

If you hear a:

- Fax tone: The other party's machine is ready for reception.
- Ring back tone: If this tone continues, the other party's machine may not be a facsimile or ran out of paper. Check with the other party.
- Busy tone: The other party's machine is busy. Let the unit continue redialing or press **STOP** and try again later.

If this feature is not required, turn it off.

- 1 Press **MENU**.
Display: 1. SYSTEM SET UP
- 2 Press **#**, then **7** **6**.
CONNECTING TONE
- 3 Press **START/COPY/SET**.
MODE=ON ▼▲
- 4 Press ▼ or ▲ to select the desired setting.
● If this feature is not required, select "OFF".
- 5 Press **START/COPY/SET**.
SETUP ITEM []
- 6 Press **MENU**.

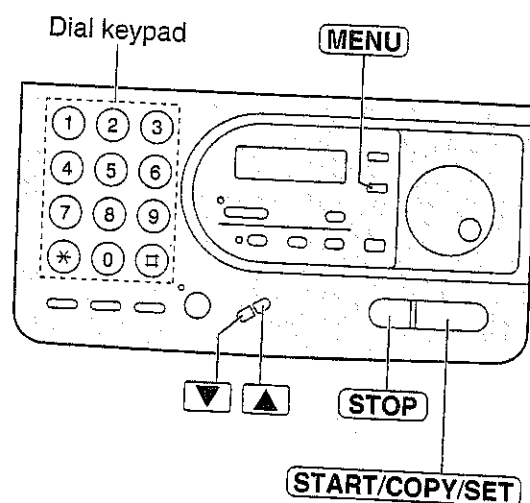

Fax/Copy

Note:

- The connecting tone volume cannot be adjusted.

Selecting the way to receive calls

This unit has four types of receive modes. Select one of these modes according to your needs.
• Regardless of the mode you select, you can always place calls and send faxes.

MANUAL RECEIVE

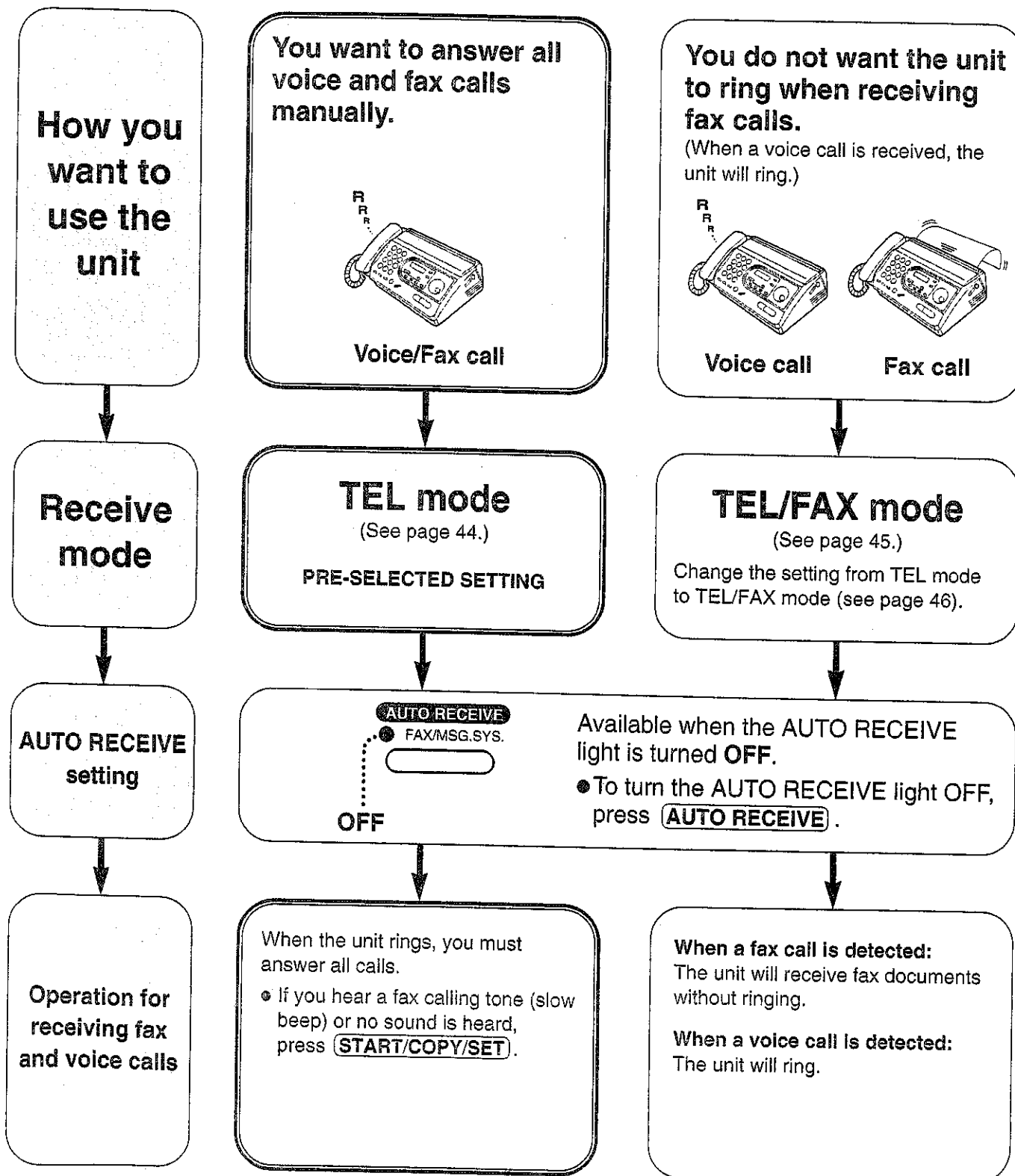

AUTO RECEIVE

You want to record voice messages and receive fax documents.



Voice/Fax call

You want to receive fax documents only.

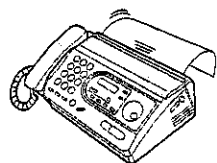

Fax call only

TAD/FAX mode

(See page 57.)

PRE-SELECTED SETTING

FAX ONLY mode

(See page 48.)

Change the setting from TAD/FAX mode to FAX ONLY mode (see page 48).

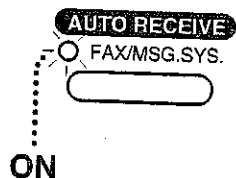

Available when the AUTO RECEIVE light is turned ON.

- To turn the AUTO RECEIVE light ON, press **AUTO RECEIVE**.

When receiving voice calls:

The unit will activate the answering device and record voice messages.

When receiving fax calls:

The unit will activate the fax function to receive documents.

The unit will automatically answer all calls and only receive fax documents.

TEL mode

(answering all calls manually)

1 When the unit rings, press **DIGITAL SP-PHONE** or lift the handset to answer the call.

2 When:
—document reception is required,
—a fax calling tone (slow beep) is heard, or
—no sound is heard,
press **START/COPY/SET**.

Display: CONNECTING

3 Hang up the handset, if using it.
• The unit will start reception.

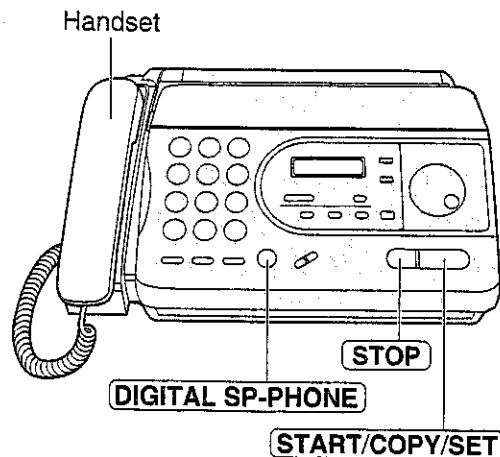

Note:

- If you do not answer the call within 15 rings, the unit will temporarily activate the answering device. If you want to change to the TAD/FAX mode, enter the remote operation ID (see page 66) during the greeting message.
- If the MANUAL RECEIVE setting is set to the TEL/FAX mode, reset it to the TEL mode (see page 46).

To stop receiving

Press **STOP**.

Friendly reception feature

When you answer a call and hear a fax calling tone (slow beep), the unit will automatically start receiving even if you do not press **START/COPY/SET**.

- If this feature is not required, set to "OFF" (see page 54).

Memory reception

When a printing problem is detected, the unit will temporarily store the received document into memory.

While documents are in memory, the unit will:
— display an error message and the following message alternately;

Display: FAX IN MEMORY

- Follow the instructions on page 77 to solve the problem and print the stored document.
- For memory capacity, see page 93.

TEL/FAX mode

(receiving voice calls with rings and fax calls without rings)

Use this mode when you wish to receive voice calls with rings, but do not want the unit to ring when faxes are received.

When a call is received, the unit will work as follows.

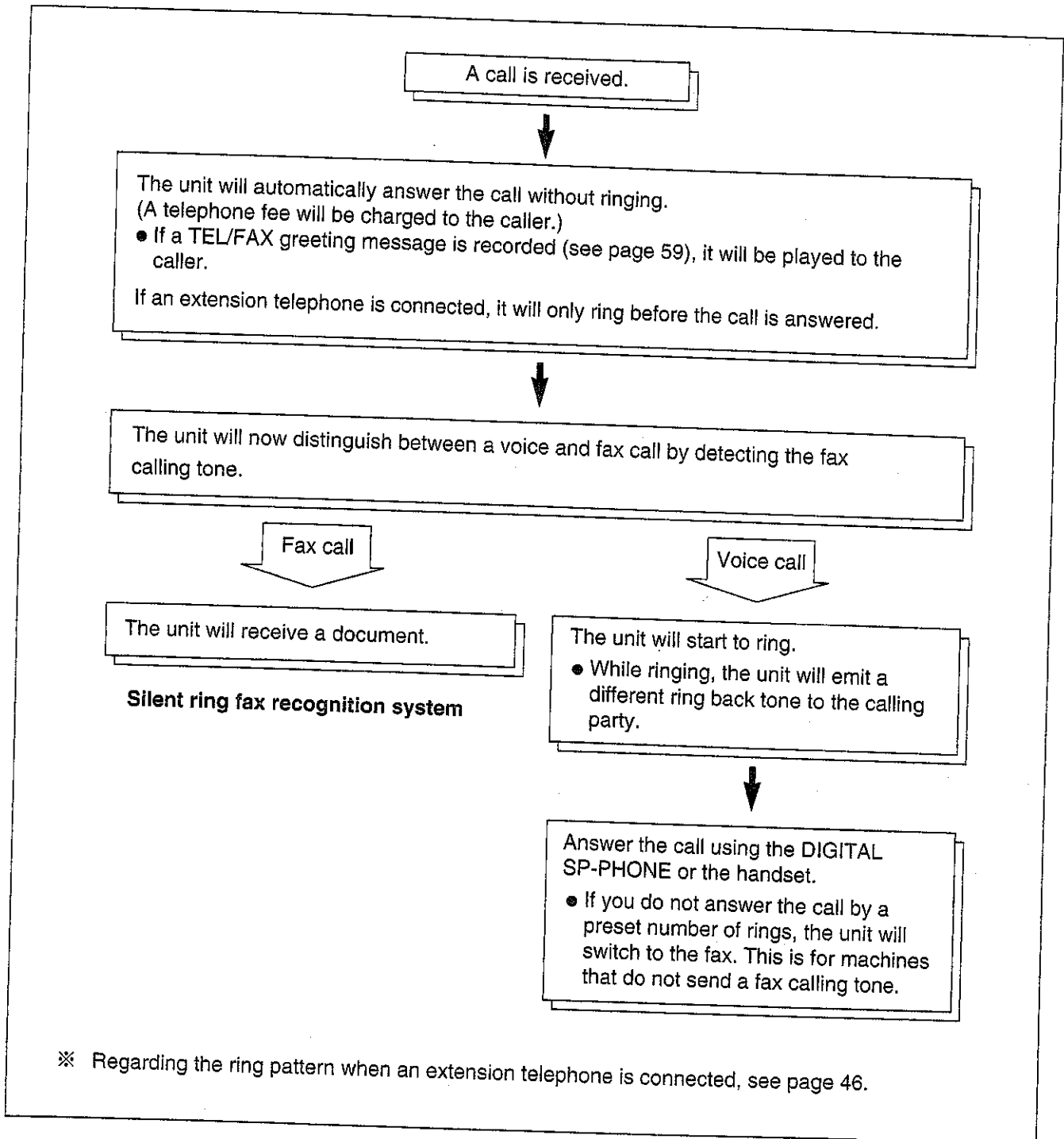

Fax/Copy

※ Regarding the ring pattern when an extension telephone is connected, see page 46.

Note:

- Some fax messages that are transmitted manually may not send a fax calling tone. These calls must be received manually.

Receiving Faxes

Ring pattern when an extension telephone is connected

When an extension telephone is connected, it will ring as follows.

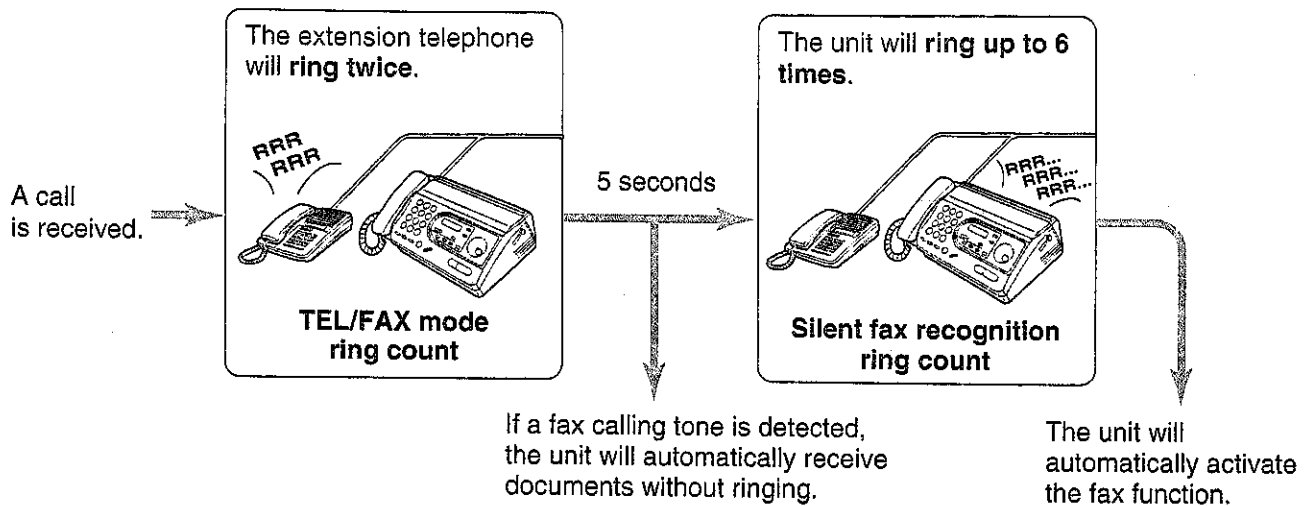

Note:

- You can change the **TEL/FAX mode ring count** and **silent fax recognition ring count** (see page 47).
- The unit will display the following when the extension telephone starts to ring.

INCOMING CALL

Changing the TEL mode to the TEL/FAX mode

Change the MANUAL RECEIVE setting from the TEL mode to the TEL/FAX mode.

- 1 Press **MENU**.
Display: 1.SYSTEM SET UP
- 2 Press **#**, then **0 8**.
MANUAL RECEIVE
- 3 Press **START/COPY/SET**.
MODE=TEL ▼▲
- 4 Press ▼ or ▲ to select "TEL/FAX".
MODE=TEL/FAX ▼▲
- 5 Press **START/COPY/SET**.
SETUP ITEM []
- 6 Press **MENU**.
- 7 If the AUTO RECEIVE light is on, turn it off by pressing **AUTO RECEIVE**.
TEL/FAX MODE

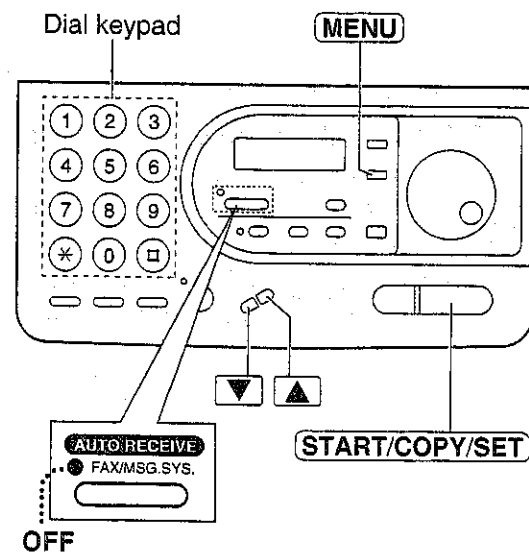

Note:

- To return to the TEL mode, select "TEL" in step 4.

Setting the TEL/FAX mode ring count

This setting determines the number of the extension telephone rings in the TEL/FAX mode. You can choose from 2 to 9 rings.

When an extension telephone is not connected, changing this setting is not necessary.

- 1 Press **MENU**.
Display: 1.SYSTEM SET UP
- 2 Press **□**, then **0 9**.
TEL/FAX RING
- 3 Press **START/COPY/SET**.
RING=2 ▼▲
- 4 Press ▼ or ▲ to select the desired number.
- 5 Press **START/COPY/SET**.
SETUP ITEM []
- 6 Press **MENU**.

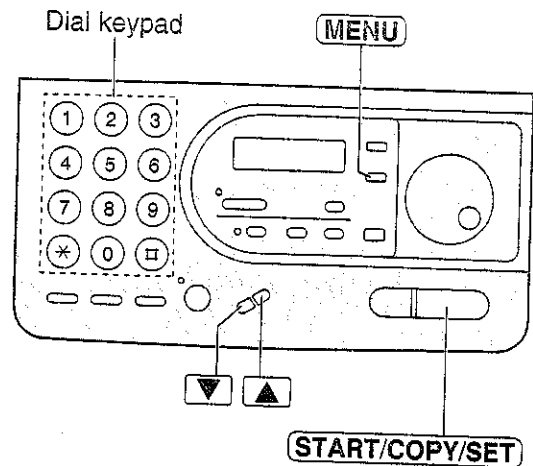

Note:

- If the number of rings is increased, you may not be able to receive documents from some older model facsimiles which do not send a fax calling tone.

Fax/Copy

Setting the silent fax recognition ring count

When the unit detects a voice call in the TEL/FAX mode, it will ring up to 6 times. The number of rings can be changed up to 9. If a voice call is not answered within the selected number of rings (3 to 9 rings), the unit will automatically start to receive a fax.

- 1 Press **MENU**.
Display: 1.SYSTEM SET UP
- 2 Press **□**, then **3 0**.
SILENT FAX RING
- 3 Press **START/COPY/SET**.
RING=6 ▼▲
- 4 Press ▼ or ▲ to select the desired number.
- 5 Press **START/COPY/SET**.
SETUP ITEM []
- 6 Press **MENU**.

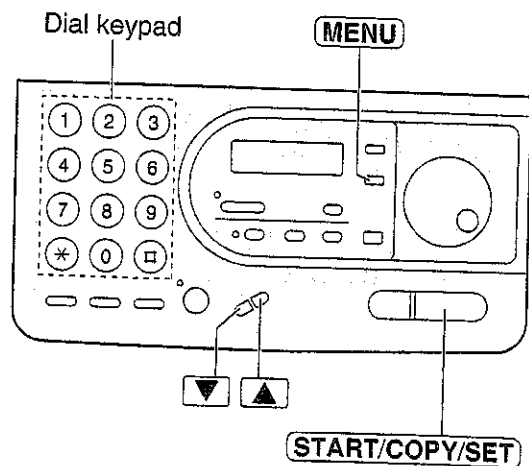

Note:

- If the number of rings is increased, you may not be able to receive documents from some older model facsimiles which do not send a fax calling tone.

Receiving Faxes

FAX ONLY mode

(all calls are received as faxes)

Activating the FAX ONLY mode

Turn on the AUTO RECEIVE mode by pressing **(AUTO RECEIVE)** until the AUTO RECEIVE light turns on.

- The display will show the following.

Display: FAX ONLY MODE

- If the AUTO RECEIVE setting is set to the TAD/FAX mode, reset it to the FAX ONLY mode (see below).
- The unit will automatically answer all calls and only receive fax documents.
- The number of rings before a call is answered can be changed (see the next page).

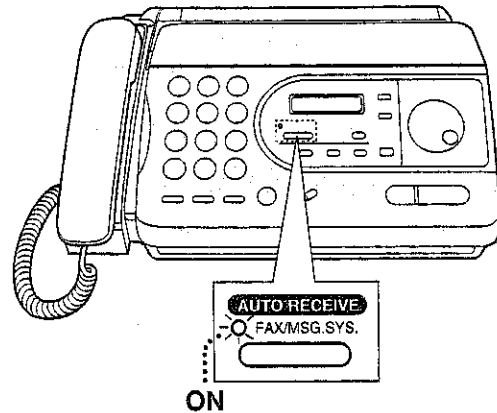

Changing the TAD/FAX mode to the FAX ONLY mode

Change the AUTO RECEIVE setting from the TAD/FAX mode to the FAX ONLY mode.

- 1 Press **(MENU)**.
Display: 1.SYSTEM SET UP
- 2 Press **(#)**, then **(0 5)**.
AUTO RECEIVE
- 3 Press **(START/COPY/SET)**.
MODE=TAD/FAX ▼▲
- 4 Press **(▼)** or **(▲)** to select "FAX ONLY".
MODE=FAX ONLY ▼▲
- 5 Press **(START/COPY/SET)**.
SETUP ITEM []
- 6 Press **(MENU)**.

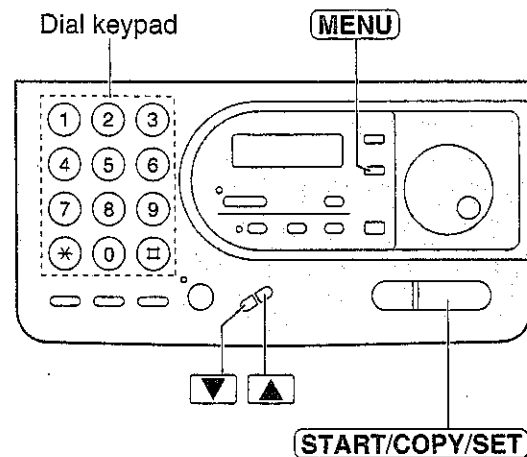

Note:

- To return to the TAD/FAX mode, select "TAD/FAX" in step 4.

Setting the FAX ONLY mode ring count

This setting determines the number of rings before the unit answers a call in the FAX ONLY mode. You can choose from 2 to 9 rings.

Helpful hints:

- To answer a call before the unit does, increase the number of rings.
- If you have difficulty receiving faxes from machines that have an automatic transmission feature, decrease the number of rings.

- 1 Press **MENU**.
Display: 1. SYSTEM SET UP
- 2 Press **07**, then **07**.
FAX RING
- 3 Press **START/COPY/SET**.
RING=2 ▼▲
- 4 Press ▼ or ▲ to select the desired number.
- 5 Press **START/COPY/SET**.
SETUP ITEM []
- 6 Press **MENU**.

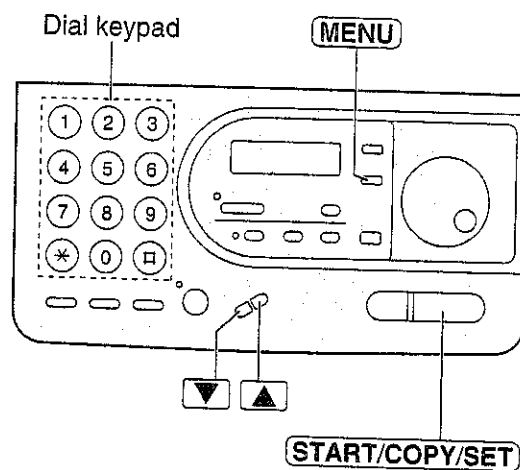

Distinctive ring service (FaxAbility) ---

Note for users in New Zealand:

Telecom has called this service "FaxAbility".

This feature is only for use if you subscribe to a distinctive ring pattern service from their telephone company. For more information on the availability of this service in your area, please contact your telephone company before setting this feature on your unit.

The distinctive ring service gives you an additional phone number on a single telephone line, with a different ringing pattern.

When you wish to use the additional phone number as a facsimile telephone number, set the ring pattern detection feature to ON. When the unit detects a call matching the distinctive ring pattern, the unit will automatically activate depending on the receive mode setting.

To use this feature properly, set the unit to the TEL/FAX mode (see page 46).

Setting the ring pattern detection ---

1 Press **MENU**.
Display: 1. SYSTEM SET UP

2 Press **#**, then **3 1**.
RING DETECTION

3 Press **START/COPY/SET**.
MODE=OFF ▼▲

4 Press ▼ or ▲ to select "ON".
• If this feature is not required, select "OFF".

5 Press **START/COPY/SET**.
PRINTING

• The unit will print an information list.

SETUP ITEM []

6 Press **MENU**.

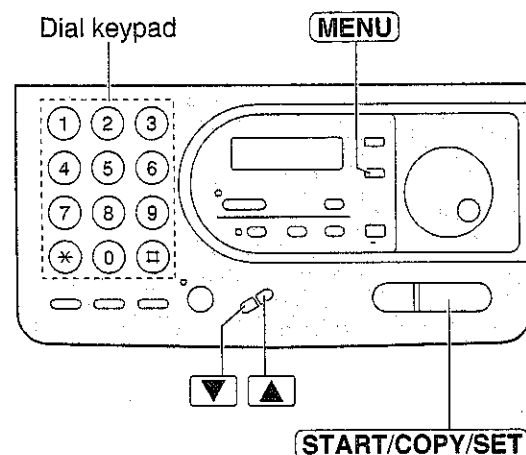

How the unit will answer in each receive mode _____

TEL/FAX mode: When a distinctive ring pattern is detected, the unit will automatically answer the call without ringing and activate the fax function.
When a standard ring pattern is received, the unit will ring until you answer the call.

TAD/FAX mode: When a distinctive ring pattern is detected, the unit will automatically answer the line and activate the fax function to receive documents.
When a standard ring pattern is received, the unit will activate the fax function or the answering device depending on the call.

TEL mode: You have to answer all calls manually.
If a fax calling tone (slow beep) is heard or no sound is heard, press **START/COPY/SET** to receive documents.

FAX ONLY mode: The unit will answer all calls automatically and activate the fax function.

Note:

- In the FAX ONLY mode, the unit automatically answers a distinctive ring call after the second ring. To change the number of rings, change the FAX ONLY mode ring count (see page 49) after setting the ring pattern detection.

Receiving Faxes

Receiving faxes using an extension telephone

When you connect an extension telephone on the same line, you can receive fax documents using the extension telephone.

You do not have to go to the unit and press **START/COPY/SET**.

Important:

- Use a touch tone telephone as the extension telephone and enter the fax activation code **firmly**.

1 When the extension telephone rings, lift the handset of the extension telephone.

2 When:
— document reception is required,
— a fax calling tone (slow beep) is heard, or
— no sound is heard,
press *** 9** (pre-selected fax activation code) **firmly**.

3 Hang up the handset.
● The unit will start reception.

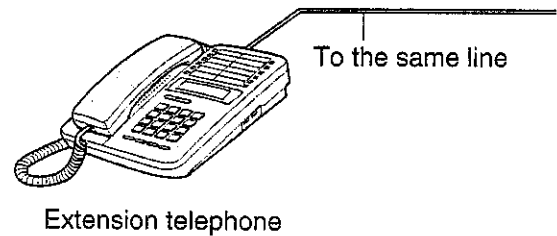

Note:

- You can change the fax activation code (see the next page).

Changing the fax activation code

The fax activation code is used when receiving faxes using an extension telephone (see page 52).

- 1 Press **MENU**.
Display: 1.SYSTEM SET UP
- 2 Press **⏏**, then **4 1**.
FAX ACTIVATION
- 3 Press **START/COPY/SET**.
MODE=ON ▼▲
- 4 Press ▼ or ▲ to select the desired setting.
● If this feature is not required, select "OFF".
- 5 Press **START/COPY/SET**.
CODE= * 9
● The display will show the pre-selected code.
- 6 Enter the new code number.
● This code can be from 2 to 4 digits in length using 0 - 9 and *.
- 7 Press **START/COPY/SET**.
SETUP ITEM []
- 8 Press **MENU**.

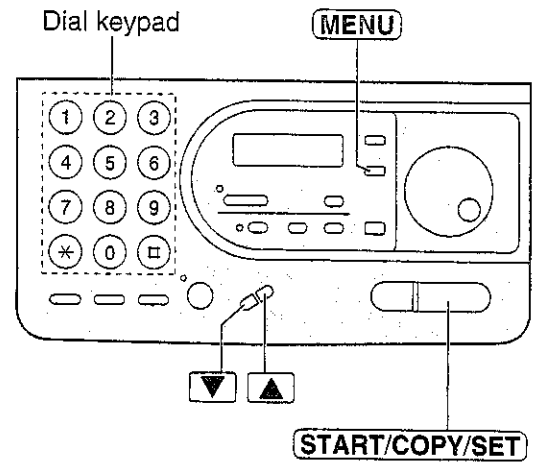

Fax/Copy

Note:

- If you subscribe to some special telephone company services, all or part of the fax activation code must be different from the service access code.
- The fax activation code should not be set to "0000".

Receive polling --- --- (retrieving faxes placed on another party's machine)

This feature allows you to retrieve a document from another compatible machine. Therefore, you pay for the call, saving the sending party the call charges.

Make sure that no documents are fed into your unit and that the other party's machine is ready for your call.

- 1 Press **MENU** three times.
 Display:

3 . POLLING
↓
YES: PRESS SET
- 2 Press **START/COPY/SET**.

NO. =

- 3 Dial the fax number.
 Example:

NO. =3331111

- 4 Press **START/COPY/SET**.

CONNECTING

- The unit will start reception.

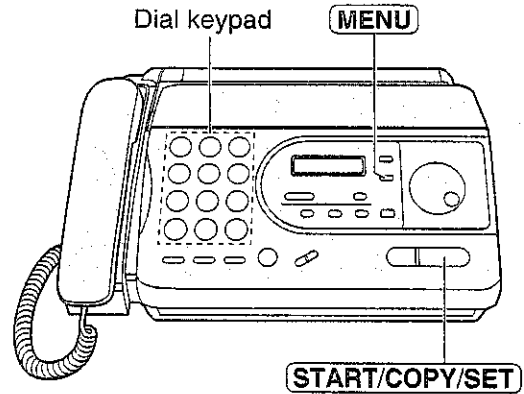

Note:

- You cannot use the EASY DIAL directory to enter the fax number for this feature.

Setting the friendly reception --- ---

The friendly reception feature allows you to receive fax documents automatically without pressing **START/COPY/SET** (see page 44).

When this feature is deactivated, you will have to press **START/COPY/SET** to receive fax documents each time you answer a fax call.

- 1 Press **MENU**.
 Display:

1 . SYSTEM SET UP

- 2 Press **□**, then **4** **6**.

FRIENDLY RCV

- 3 Press **START/COPY/SET**.

MODE=ON	▼ ▲
---------	-----
- 4 Press **▼** or **▲** to select the desired setting.
 • If this feature is not required, select "OFF".
- 5 Press **START/COPY/SET**.

SETUP ITEM []

- 6 Press **MENU**.

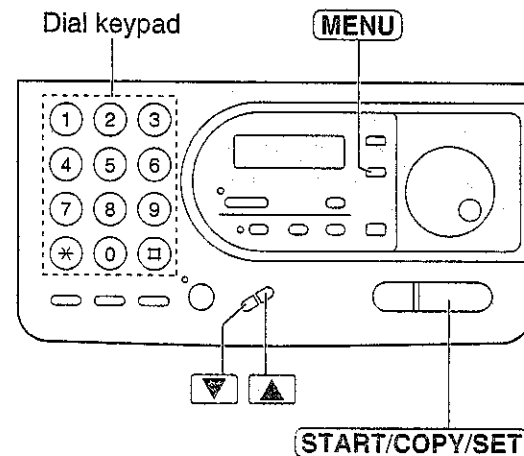

Signaling your pager when your unit receives a fax

This feature allows your unit to call your pager when your unit receives a fax document.

1 Press **MENU**.
 Display: 1.SYSTEM SET UP

2 Press **[FAX]**, then **7 0**.
 FAX PAGER

3 Press **START/COPY/SET**.
 MODE=OFF

4 Press **▼** or **▲** to select "ON".
 MODE=ON

• If this feature is not required, select "OFF".

5 Press **START/COPY/SET**.
 NO. =

6 Enter your pager number.
 • You can enter a total of 46 digits and/or pauses.
 Example: NO. =1122333

7 Press **START/COPY/SET**.
 SETUP ITEM []

8 Press **MENU**.

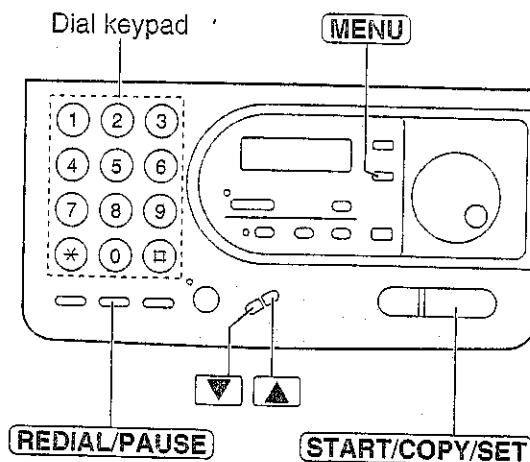

Note:

- If this feature does not work properly, enter more than one pause by pressing **REDIAL/PAUSE** at the end of your pager number to extend the paging time.
- If you wish to display a message on your pager, enter your pager number, pause(s) and the message.
- Message programming methods may vary depending on the pager company. Contact your pager company for details.

Fax/Copy

Copying

Making a copy

Any transmittable document (see page 35) can be copied.

- 1 Open the document feeder tray.
- 2 Adjust the width of the document guides to the size of the document.
- 3 Insert the document (up to 10 sheets) **FACE DOWN** until a beep tone is heard.

Display:

- 4 Press **RESOLUTION** repeatedly to select the desired setting, if necessary (see the bottom of page 33).

- 5 Press **START/COPY/SET**.

- The unit will start printing.

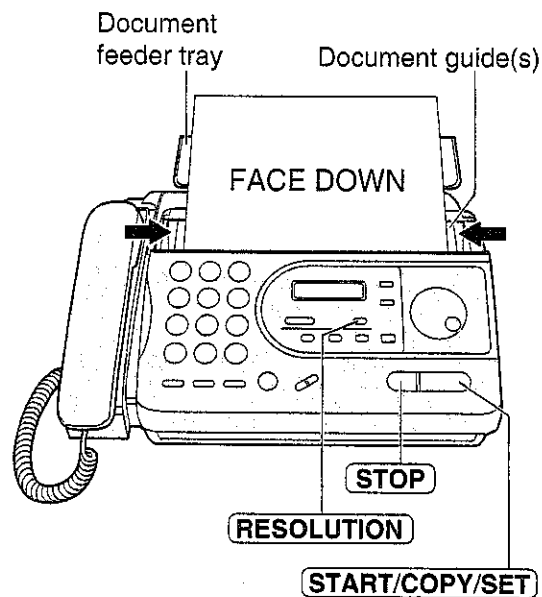

Note:

- When you copy a multiple page document which is longer than A4 size paper (approx. 300 mm), we recommend to insert the pages one at a time.
- If a resolution is not set, FINE resolution will automatically be selected.
- You can make or receive a voice call while making a copy.

To stop copying

Press **STOP**.

To eject the document, press **STOP** again.

TAD/FAX mode --- ---

(using the built-in answering device and receiving voice and fax calls automatically)

When you turn on AUTO RECEIVE (the pre-selected setting is TAD/FAX), the unit will work as a facsimile machine and/or answering device.

If a fax call is detected, the unit will automatically switch to receive faxes.

If a voice call is detected, the answering device will begin recording and the caller can leave a voice message.

- You can use a pre-recorded greeting message (see page 58) or record your own greeting message (see page 59).

Setting up the voice message and document reception ---

The total recording time (including the greeting messages) is about 20 minutes. If messages are recorded in a noisy room, the recording time may be shortened.

To set the unit to record incoming voice messages and receive fax documents, follow the steps below.

- 1 Select "TAD/FAX" in step 4 of feature setting #05 (see page 48).
- 2 If the AUTO RECEIVE light is off, turn it on by pressing **AUTO RECEIVE**.
 - The unit will play the TAD/FAX greeting message and the display will show the following message.

Display: TAD/FAX MODE

The remaining time for recording incoming messages will be displayed.

Example: TIME = 10m13s

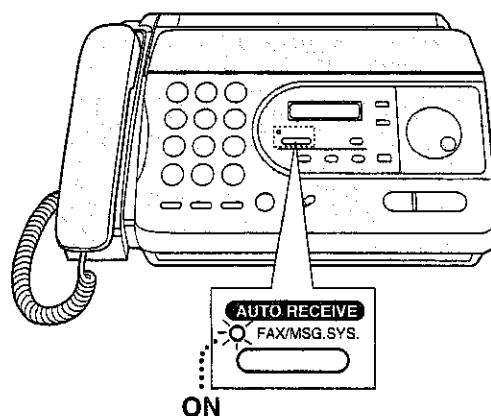

Answering Device

Note:

- Each incoming message recording time can be set to either 1 minute or unlimited. To change the setting, see page 74.
- When the remaining time is low, erase unnecessary messages from memory (see pages 62 and 68).
- While an incoming call is being recorded, you can monitor it through the speaker. If this feature is not required, set the ICM monitor feature to "OFF" (see page 75).

Greeting

Pre-recorded greeting messages

The unit has pre-recorded greeting messages. Depending on the situation, one of the following messages will be played to the caller.

- When you do not record your own greeting message (see the next page), the following message will be played.

*Hello! We are unable to answer right now.
To send a fax, please start transmission.
To leave a voice message, please speak after the beep.
Thank you.*

Note:

- If you erase your own greeting message, the pre-recorded greeting message will be played automatically.

- When the unit detects a problem, one of the following pre-recorded greeting messages will be played.

MEMORY FULL

*Hello! We are unable to answer right now.
To send a fax, please start transmission.
To leave a voice message, please try again later.
Thank you.*

MEMORY FULL and
OUT OF PAPER
OR
MEMORY FULL and
UNIT OVERHEATED

*Hello! We are unable to answer right now.
Please try again later.
Thank you.*

Recording your own greeting messages

The recording time is limited to 16 seconds for each message. Record your message within 12 seconds for best performance.

- You can choose either 16 seconds or 60 seconds of recording time for the TAD/FAX greeting message (see page 61).

Suggested messages

TAD/FAX greeting message	"This is (your name, business and/or telephone number). We are unable to answer right now. To send a fax, start transmission. To leave a message, speak after the beep. Thank you."
TEL/FAX greeting message	"This is (your name, business and/or telephone number). We are unable to answer right now. Please try again later. Thank you."

Note:

- If you do not record the TAD/FAX greeting message, the pre-recorded message will be played (see page 58).

Recording a greeting message

1 For the TAD/FAX greeting:

Press **RECORD** two times.

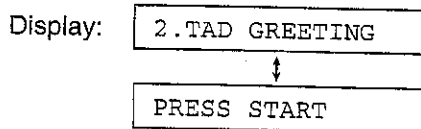

For the TEL/FAX greeting:

Press **RECORD** three times.

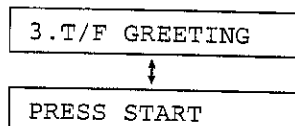

2 Press **START/COPY/SET**.

- A long beep will sound and the display will show as follows.

For the TAD/FAX greeting:

TAD REC. 16s

For the TEL/FAX greeting:

T/F REC. 16s

3 Speak clearly about 20 cm (8 inches) away from the microphone.

- The display will show the remaining recording time.

Example: TAD/FAX greeting

TAD REC. 15s

4 When finished, press **STOP**.

- The unit will repeat your message. You can adjust the volume using ▼ or ▲.

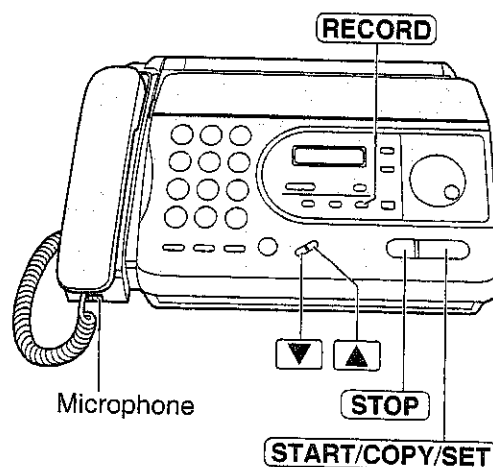

Erasing your own recorded greeting messages

1 For the TAD/FAX greeting:

Press **ERASE** two times.

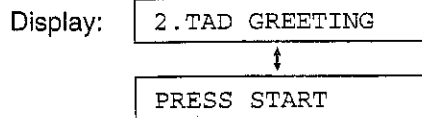

For the TEL/FAX greeting:

Press **ERASE** three times.

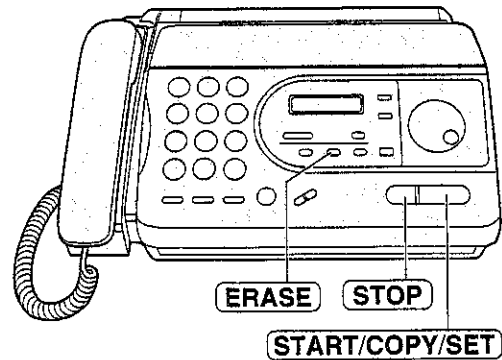
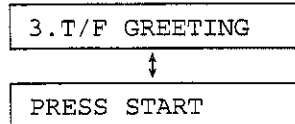

2 Press **START/COPY/SET**.

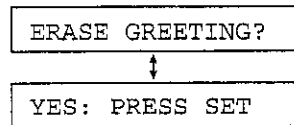

• To stop erasing, press **STOP**.

3 Press **START/COPY/SET**.

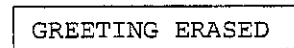

Note:

- If you erase your own TAD/FAX greeting message, the pre-recorded greeting message will be played.

Recording time for the TAD/FAX greeting message

You can choose either 16 seconds or 60 seconds of recording time.

- 1 Press **MENU**.
Display: 1.SYSTEM SET UP
- 2 Press **#**, then **5** **4**.
GREETING TIME
- 3 Press **START/COPY/SET**.
MODE=16s ▼▲
- 4 Press ▼ or ▲ to select the desired setting.
- 5 Press **START/COPY/SET**.
SETUP ITEM []
- 6 Press **MENU**.

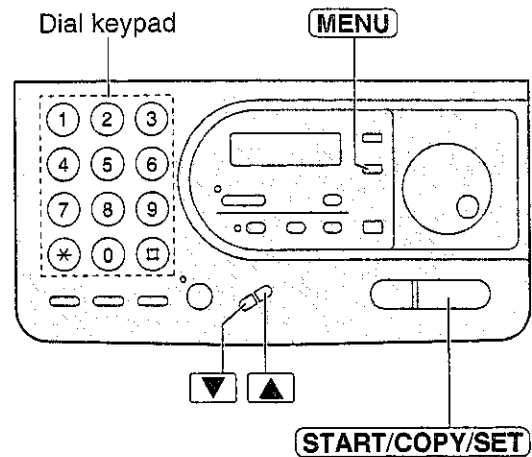

Note:

- If you change the greeting message time to 60 seconds, we recommend that you tell the caller in the TAD/FAX greeting message to press *9 before starting fax transmission.
- If you change the greeting message time to 16 seconds from 60 seconds, your recorded TAD/FAX greeting message will be deleted. Re-record a greeting message (see page 59).

Playing Messages

Listening to recorded messages

- When the unit receives voice messages;
- the PLAY MESSAGES light will flash,
 - the call counter will show the total number of recorded messages, and
 - slow beeps will sound if message alert (page 74) is set to "ON".

When the PLAY MESSAGES light is flashing

Press **PLAY MESSAGES**.

- Only the new recorded messages will be played.

When the PLAY MESSAGES light is on

Press **PLAY MESSAGES**.

- All messages will be played.

Note:

- During playback, the display shows the recorded order of the messages.
- You can adjust the speaker volume using **▼** or **▲**.
- The number of calls in the call counter will not decrease until you erase the recorded messages.

Voice time/day stamp:

During playback, a synthesized voice will announce the time and day of the week when each message was recorded.

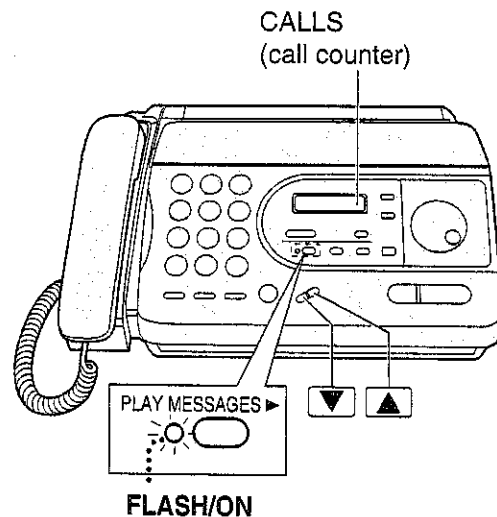

Erasing recorded messages

Erase unnecessary messages to prevent memory from becoming full.

Erasing a specific message

Press **ERASE** while listening to the message you want to erase.

Erasing all the messages

1. Press **ERASE** after listening to all of the messages.

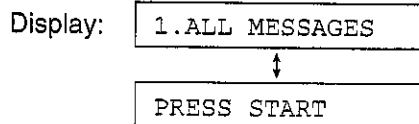

2. Press **START/COPY/SET**.

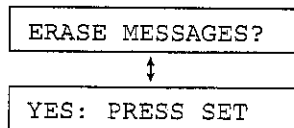

- To stop erasing, press **STOP**.

3. Press **START/COPY/SET**.

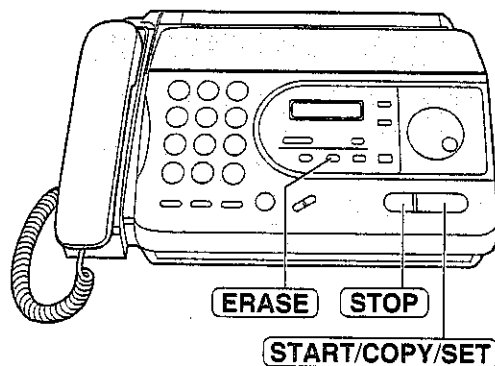
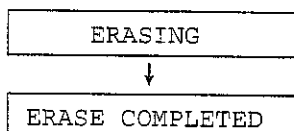

Functions while playing a message (repeating, skipping and stopping)

Repeating a message

Press **1** or rotate **EASY DIAL** one click to the left while listening to the message you want to repeat.

- If you press **1** or rotate **EASY DIAL** within 5 seconds of the beginning of the message, the previous message will be played.
- To play back a specific message, press **1** repeatedly or rotate **EASY DIAL** to the left until you hear the message you want to repeat.

Skipping a message

Press **3** or rotate **EASY DIAL** one click to the right to play the next message.

Changing the playback speed

Press **QUICK** to play messages at one and a half times the original speed.

Press **SLOW** to play messages at a half the original speed.

- To return to the original speed, press **QUICK** or **SLOW** again during quick or slow playback.

Stopping playback

Press **STOP**.

- To resume playing the recorded messages, press **PLAY MESSAGES** within 1 minute.

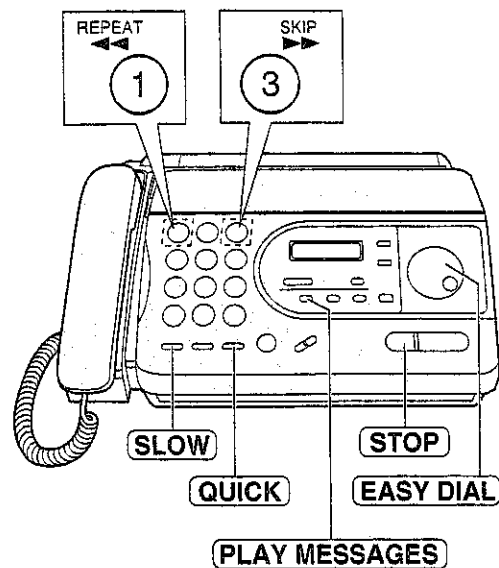

Recording

Memo message

(leaving a message for others or yourself)

To leave a private message for someone or yourself, you can record a voice memo. This memo can be played back later, either directly or remotely.

- 1 Press **RECORD**.

Display: 1. MEMO MESSAGE

PRESS START

- 2 Press **START/COPY/SET**.

- A long beep will sound.

MEMO RECORDING

- 3 Speak clearly into the microphone.

- 4 When finished, press **STOP**.

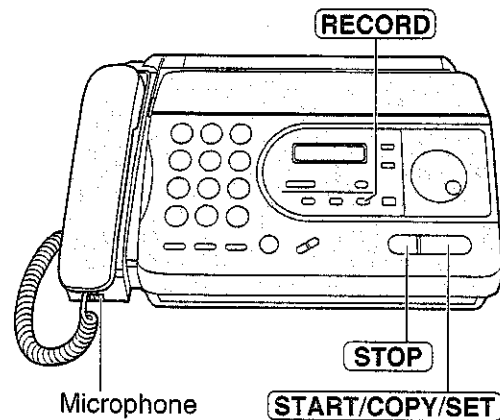

Telephone conversation

You can record a telephone conversation.

- 1 During the telephone conversation, press **RECORD**.

Display: 2WAY RECORDING

- 2 To stop recording, press **STOP** or hang up the handset.

Note:

- This feature is not available when using the DIGITAL SP-PHONE button.
- All persons using this device for recording telephone conversations shall comply with New Zealand law. This requires that at least one party to the conversation is to be aware that it is being recorded. In addition, the Principles enumerated in the Privacy Act 1993 shall be complied with in respect to the nature of the personal information collected, the purpose for its collection, how it is used and what is disclosed to any other party.

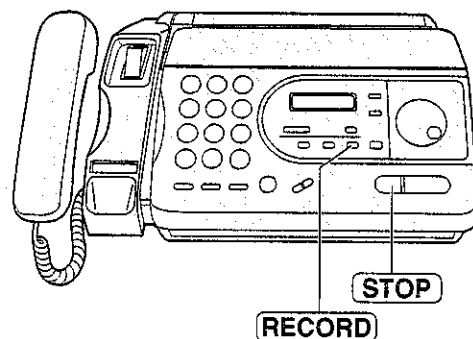

Operating from a remote location

The following operations can be performed from a remote location using a touch tone telephone. **Set the unit to the TAD/FAX mode before going out (see page 57).**

Dial key	Remote command	Page	Dial key	Remote command	Page
0	Skips the greeting message	69	9	Stops re-recording of a greeting message	68
1	Repeats a message	67	*4	Erases a specific message	68
2	Skips a message	67	*5	Erases all messages	68
4	New message playback	67	80	Changes to the TEL mode	69
5	All message playback	67	81	Turns ON message transfer/pager call for incoming messages	69
7	Re-records a greeting message	68	82	Turns OFF message transfer/pager call for incoming messages	69

Remote operation card

Please cut out and carry this card for assistance when using the remote operation.

<div style="border: 1px solid black; padding: 2px; text-align: center; margin-bottom: 5px;">Answering Device Remote Operation</div> <ol style="list-style-type: none"> 1. Call your unit. 2. Enter the remote operation ID <input style="width: 20px; height: 15px; border: 1px solid black; margin: 2px 5px;" type="text"/> during the greeting message. <ul style="list-style-type: none"> ● The new recorded messages will be played automatically. 3. Press the remote command key(s) (see the reverse side) within 10 seconds. <hr style="width: 50%; margin: 5px auto;"/> <p style="font-size: small;">If there are no new messages, press the remote command key(s) within 4 seconds. or Wait for 4 seconds, and all the recorded messages will be played back.</p>	<div style="border: 1px solid black; padding: 2px; text-align: center; margin-bottom: 5px;">Notice of Remote Operation</div> <ul style="list-style-type: none"> ● The remote operation is available only from a touch tone telephone when the unit is in the TAD/FAX mode. ● When the unit is in the TEL mode, call your unit and wait for 15 rings. The answering device will temporarily answer the line. Enter the remote operation ID during the greeting message. The unit will switch to the TAD/FAX mode. ● When you press any key, press firmly. ● To send a document, press *9. When a fax tone is heard, start transmission.
--	---

Fold here

Answering Device

Remote Operation

Setting the remote operation ID

The remote operation ID is used to access the answering device.
Choose any 3-digit number except a number using digits 0 or 7.

- 1 Press **MENU**.
Display: 1.SYSTEM SET UP
- 2 Press **▣**, then **1 1**.
REMOTE TAD ID
- 3 Press **START/COPY/SET**.
ID=111
- 4 Enter the desired number.
- 5 Press **START/COPY/SET**.
SETUP ITEM []
- 6 Press **MENU**.

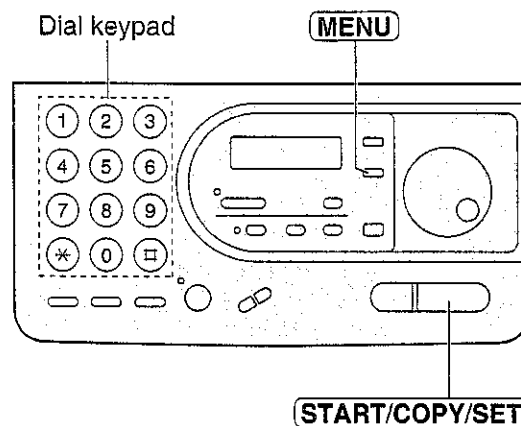

Key	Remote command
0	Skips the greeting message
1	Repeats a message
2	Skips a message
4	New message playback
5	All message playback
7	Re-records a greeting message

Key	Remote command
9	Stops re-recording of a greeting message
*4	Erases a specific message
*5	Erases all messages
80	Changes to the TEL mode
81	Message transfer/ Pager call ON
82	Message transfer/ Pager call OFF

From a remote touch tone telephone

Listening to messages

- 1** Call your unit.
- 2** Enter the remote operation ID during the TAD/FAX greeting playback.
 - The voice guide will tell you the number of new recorded messages and play them automatically.
 - You can repeat the new recorded messages by pressing **[4]** in the same call.
- 3** Press **[5]** to listen to all of the recorded messages.

Voice guide example:

3 new messages.

When there are no new recorded messages

The voice guide will tell you "No new messages." in step 2.

Press **[5]** or wait for 4 seconds to listen to all of the recorded messages.

During playback

Repeating a message

Press **[1]** to play the current message.

—If you press **[1]** within 5 seconds of the beginning of a message, the previous message will be played.

Skipping a message

Press **[2]**.

Note:

- If the voice guide prompts you that memory is full after playing the message, erase some or all of the messages.

Voice guide example:

Sorry, no more memory. Please erase unnecessary messages.

Remote Operation

Erasing incoming messages from memory

Erasing a specific message

Press **[*] 4** while listening to the message you want to erase.

- A long beep and the voice guide will be heard.
Then the unit will continue with the next message.

Voice guide example:

The message has been erased.

Erasing all messages

Press **[*] 5** to erase all messages.

- A long beep and the voice guide will be heard.

Voice guide example:

All messages have been erased.

Other remote operations

Recording a marker message

After playing back the recorded messages, you can leave an additional message.

1. Wait for the voice guide to tell you that the remote operation has ended.
2. Wait about 10 seconds for the voice guide to prompt you to leave a message.
3. Leave a message after the beep.

Voice guide example:

All messages have been played.

Please leave your name and message after the beep.

Re-recording a greeting message

You can change the contents of the greeting message for the TAD/FAX mode.

1. Press **[7]** to start recording.
 - A long beep will sound.
2. Speak clearly up to 16 seconds.
 - If you pause for over 2 seconds, 6 beeps will sound and the recording will stop. Repeat from step 1 within 10 seconds.
3. When finished, press **[9]**.
 - The new greeting message will be played.

Changing to the TEL mode

You can change the setting of the receive mode from TAD/FAX to TEL from a remote location.

1. Call your unit.
2. Enter your remote operation ID.
3. Press **8 8 0**.

Turning the message transfer/pager call on or off

You must pre-program a transfer telephone number or a pager number (see page 72) before using this feature.

Press **8 1** to turn ON the message transfer/pager call.

Press **8 2** to turn OFF the message transfer/pager call.

— If a transfer telephone number or a pager number is not programmed, you cannot turn this feature ON. The voice guide will prompt you.

Voice guide example:

*Message transfer is set.
Transfer phone number is 123456789.
or
Pager call is set.
Pager number is 098765432.*

*Message transfer is off.
or
Pager call is off.*

*Transfer phone number is not set.
or
Pager number is not set.*

Skipping the greeting message

Press **0** during the greeting message playback.

— The unit will skip the rest of the greeting message.

Transferring recorded messages to another phone

This feature allows your unit to call a designated telephone or pager number each time an incoming voice message is recorded.

You can choose **Message transfer** or **Pager call**.

Message transfer: Program the transfer telephone number first. When an incoming message is recorded in your unit, the message will be transferred. You can retrieve the message during the same call using the remote operation.

Pager call: Program the pager number first. When an incoming call is recorded, your pager will be called. Call your unit and retrieve the message using the remote operation.

- This feature operates in the TAD/FAX mode.
- For details on the remote operation, see page 65.
- Use a touch tone telephone to access your unit.

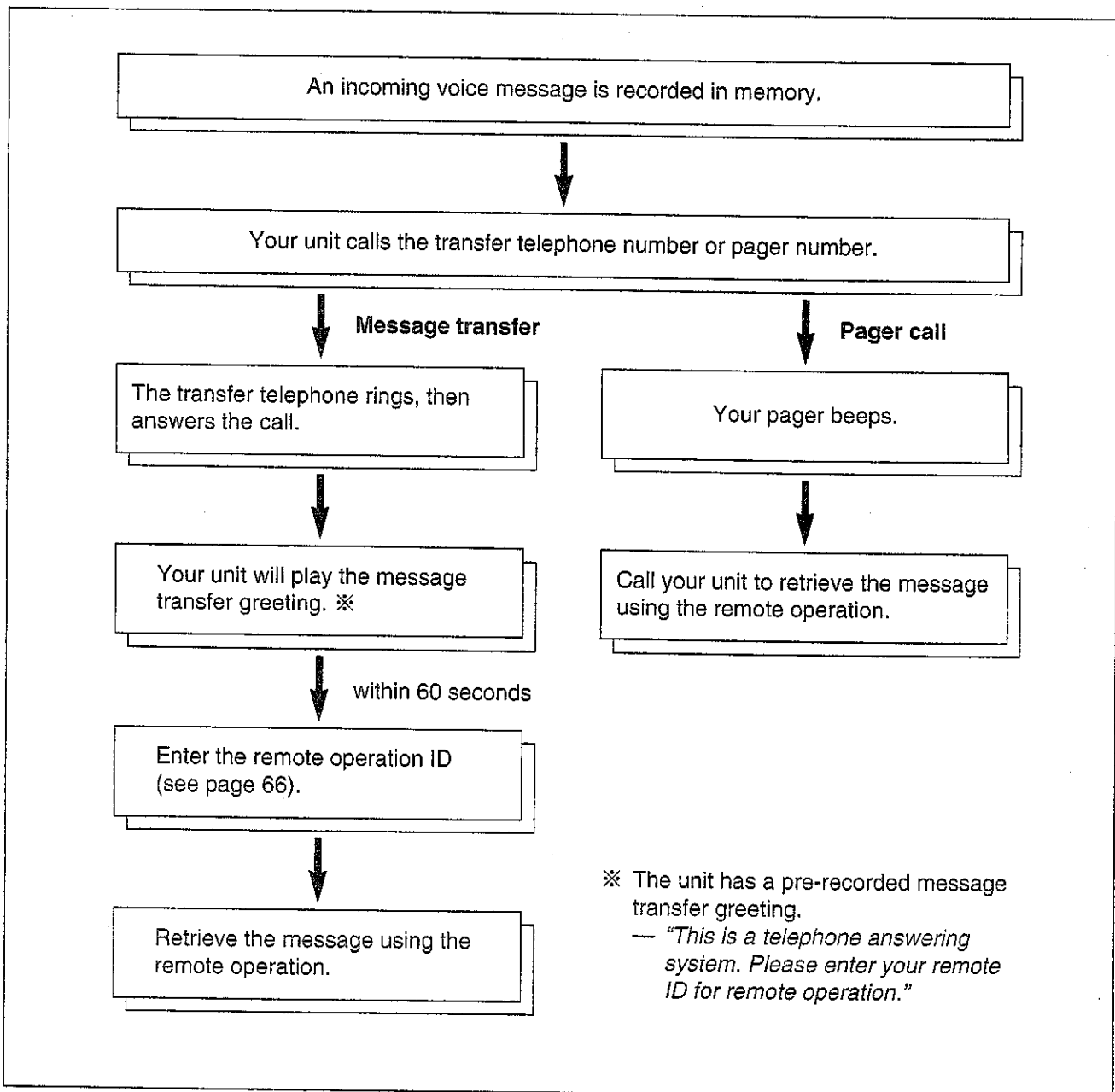

Recording a message transfer greeting message

The recording time is limited to 16 seconds. Record your message within 12 seconds for best performance.

Suggested message

Message transfer greeting message	"This is a transferred message from (your name, business and/or telephone number). Please enter your remote ID for the remote operation."
-----------------------------------	---

Note:

- If you do not record a message, the pre-recorded message will be played (see page 70).

- 1 Press **MENU**.
Display: 1. SYSTEM SET UP
- 2 Press **☐**, then **6 1**.
TRNS - GREETING
- 3 Press **START/COPY/SET**.
CHECK ▼▲
- 4 Press ▼ or ▲ to select "RECORD".
RECORD ▼▲
- 5 Press **START/COPY/SET**.
TRNS REC. 16s
- 6 Speak clearly about 20 cm (8 inches) away from the microphone.
• The display will show the remaining recording time.
Example: TRNS REC. 15s
- 7 When finished, press **STOP**.
• The unit will repeat your message. You can adjust the volume using ▼ or ▲.
- 8 To exit the program, press **MENU**.

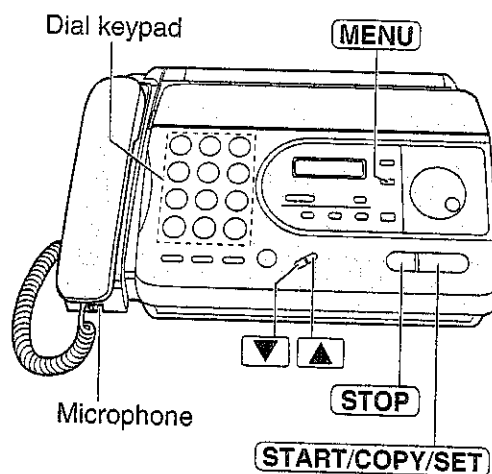

To check your message

Select "CHECK" by pressing ▼ or ▲ in step 4, and press **START/COPY/SET**.

- The unit will play your message.
- To exit the program, press **MENU**.

To erase your message

Select "ERASE" by pressing ▼ or ▲ in step 4, and press **START/COPY/SET**.

To exit the program, press **MENU**.

- The pre-recorded greeting message will be played instead of your message.

Options

Setting the message transfer/pager call

1 Press **MENU**.
Display: 1.SYSTEM SET UP

2 Press **▣**, then **6 0**.
MESSAGE TRANS.

3 Press **START/COPY/SET**.
MODE=OFF ▼▲

4 Press ▼ or ▲ to select "MESSAGE" or "PAGER".

MESSAGE: transfers incoming messages.

PAGER: calls your pager.

OFF: turns off this feature.

● If this feature is not required, select "OFF".

5 Press **START/COPY/SET**.
NO. =

6 a: If you selected "MESSAGE" in step 4:
Enter the transfer telephone number.

b: If you selected "PAGER" in step 4:
Enter your pager number.

● You can enter a total of 46 digits and/or pauses.

Example:

1 202 555 1234 PPP 12345678 PPP 5555 #

Your pager number

Pauses

Your pager access code, if required.

Message you want displayed on your pager when a voice message is recorded.

7 Press **START/COPY/SET**.
SETUP ITEM []

8 Press **MENU**.

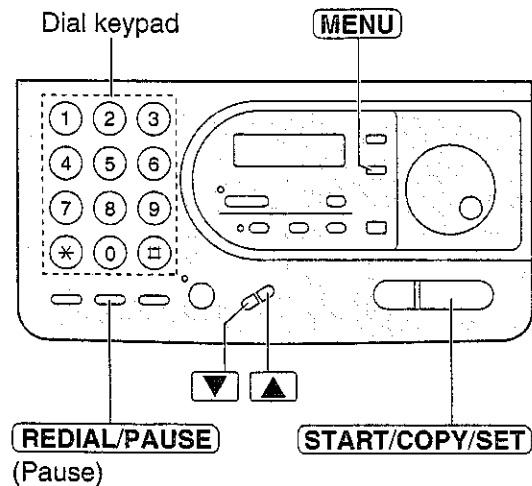

Note:

● This feature can be turned on/off remotely from a touch tone telephone (see page 69).

How your unit and pager work

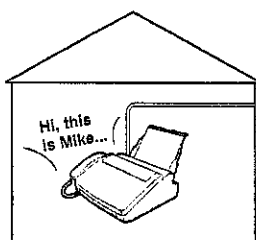

When your unit receives a voice message, it will call your pager company.

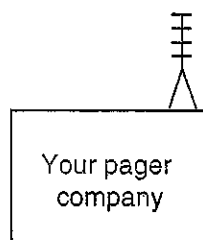

Your pager company will call your pager.

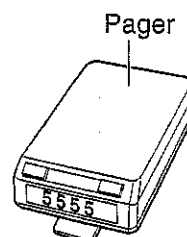

A few minutes later, your pager will display the same message you entered in step 6. (For example: 5555)

Ring count in the TAD/FAX mode

This feature determines the number of rings before the unit answers a call in the TAD/FAX mode. You can choose from 2 to 9, TOLL SAVER and RINGER OFF.

TOLL SAVER: When you call the unit from a remote location, the number of rings will tell you if there are any new voice messages. If the unit answers on the second ring, there is at least one new recorded message. If the unit answers on the fourth ring, there are no new recorded messages. To save the toll charges for the call, hang up immediately when you hear the third ring. The third ring indicates that there are no new recorded messages.

RINGER OFF: The unit will answer without ringing.

Helpful hints:

- To answer a call before the unit does, increase the number of rings.
- If you find difficulty in receiving faxes from machines that have an automatic transmission feature, decrease the number of rings.

- 1 Press **MENU**.
Display: 1.SYSTEM SET UP
- 2 Press **☐**, then **0 6**.
TAD/FAX RING
- 3 Press **START/COPY/SET**.
RING=2 ▼▲
- 4 Press ▼ or ▲ to select the desired setting.
- 5 Press **START/COPY/SET**.
SETUP ITEM []
- 6 Press **MENU**.

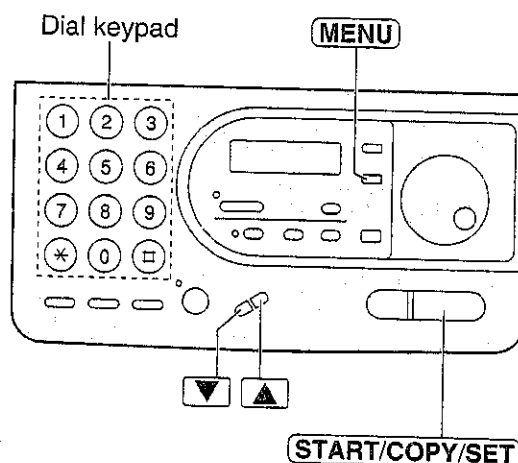

Incoming message recording time

You can choose from two recording times for an incoming message.

VOX (unlimited): The unit will record an incoming message as long as the caller talks (pre-selected setting).

1 MIN (1 minute): The unit will record each incoming message up to 1 minute.

- 1 Press **MENU**.
Display: 1.SYSTEM SET UP
- 2 Press **□**, then **1 0**.
RECORDING TIME
- 3 Press **START/COPY/SET**.
MODE=VOX ▼▲
- 4 Press ▼ or ▲ to select the desired setting.
- 5 Press **START/COPY/SET**.
SETUP ITEM []
- 6 Press **MENU**.

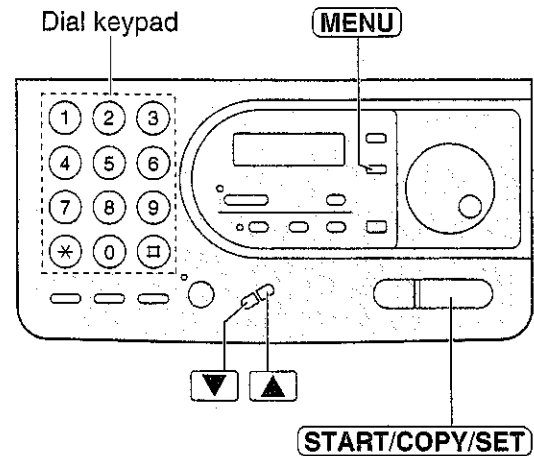

Message alert (beeps when a voice message is received)

When this feature is on, the unit will let you know with slow beeps that a caller's message has been recorded.

- 1 Press **MENU**.
Display: 1.SYSTEM SET UP
- 2 Press **□**, then **4 2**.
MESSAGE ALERT
- 3 Press **START/COPY/SET**.
MODE=OFF ▼▲
- 4 Press ▼ or ▲ to select "ON".
MODE=ON ▼▲
- If this feature is not required, select "OFF".
- 5 Press **START/COPY/SET**.
SETUP ITEM []
- 6 Press **MENU**.

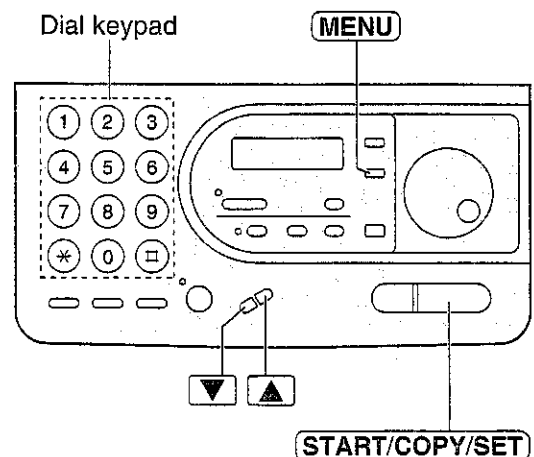

Recording time alert --- ---

(beeps when memory is almost full)

When there is less than 60 seconds of recording time for incoming messages, the unit will alert the user with slow beeps.

- 1 Press **MENU**.
Display: 1. SYSTEM SET UP
- 2 Press **Ⓜ**, then **4 3**.
REC. TIME ALERT
- 3 Press **START/COPY/SET**.
MODE=OFF ▼▲
- 4 Press ▼ or ▲ to select "ON".
MODE=ON ▼▲
 - If this feature is not required, select "OFF".
- 5 Press **START/COPY/SET**.
SETUP ITEM []
- 6 Press **MENU**.

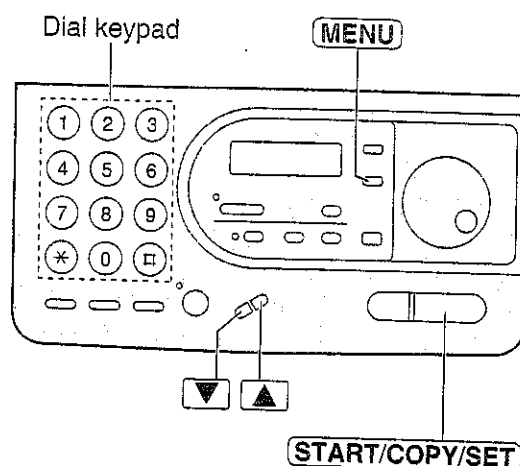

Setting the ICM monitor --- ---

When a call is received with the answering device, the incoming messages will be heard from the speaker during the call. If you do not want the messages to be heard by other persons who share your unit, set this feature to "OFF".

- 1 Press **MENU**.
Display: 1. SYSTEM SET UP
- 2 Press **Ⓜ**, then **6 7**.
ICM MONITOR
- 3 Press **START/COPY/SET**.
MODE=ON ▼▲
- 4 Press ▼ or ▲ to select "OFF".
MODE=OFF ▼▲
 - If this feature is required, select "ON".
- 5 Press **START/COPY/SET**.
SETUP ITEM []
- 6 Press **MENU**.

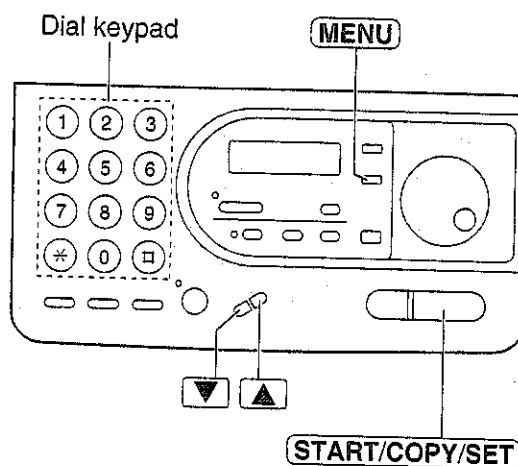

Error Messages

Error messages on printed reports

When a problem has occurred, one of the following messages will be printed on the transmission and journal reports (see pages 37 and 38).

Communication message	Error code	Cause & Remedy
COMMUNICATION ERROR	41-72 FF	● A transmission or reception error occurred. Try again or check with the other party.
DOCUMENT JAMMED	—	● The document is jammed. Remove the jammed document (p. 82).
ERROR-NOT YOUR UNIT	53, 54 59, 70	● A transmission or reception error occurred because of a problem with the other party's machine. Check with the other party.
MEMORY FULL	—	● The document was not received due to memory being full.
NO DOCUMENT	—	● The document was not fed into the unit properly. Reinsert the document and try again.
OTHER FAX NOT RESPOND	—	● The other party's machine was busy or ran out of recording paper. Try again. ● The document was not fed properly. Reinsert the document and try again. ● The other party's machine rings too many times. To send a fax manually, dial the number, confirm the fax tone, and press START/COPY/SET . ● The other party's machine is not a facsimile. Check with the other party.
PAPER JAMMED	—	● The recording paper is jammed. Clear the jammed paper (p. 81).
PAPER OUT	—	● The unit ran out of recording paper. Install a recording paper roll (p. 19).
PRESSED THE STOP KEY	—	● The STOP button was pressed and fax communication was canceled.
PRINTER OVERHEATED	—	● The printer overheated. Let the unit cool down.
THE COVER WAS OPENED	—	● The cover was opened. Close it and try again.
OK	—	● Fax communication was successful.

Error messages on the LCD display



If the unit detects a problem, one or more of the following messages will appear on the display.

Display message	Cause & Remedy
CALL SERVICE	<ul style="list-style-type: none"> There is something wrong with the unit. Contact your service personnel.
CHECK COVER	<ul style="list-style-type: none"> The cover is open. Close it.
CHECK DOCUMENT	<ul style="list-style-type: none"> The document is not fed into the unit properly. Reinsert the document and try again. If misfeeding occurs frequently, clean the document feeder rollers (p. 84). If the problem remains, adjust the feeder pressure (p. 83). Attempted to transmit a document longer than 600 mm (23⁵/₈"). Press the STOP button to remove the document. Divide the document into two or more sheets and try again.
CHECK MEMORY	<ul style="list-style-type: none"> Memory (telephone numbers, parameters, etc.) has been erased. Re-program.
DIRECTORY FULL	<ul style="list-style-type: none"> There is no space to store new stations in the EASY DIAL directory. Edit or erase unnecessary stations (p. 30).
FAX IN MEMORY	<ul style="list-style-type: none"> The unit has (a) document(s) in memory. See the other message instructions to print out the document(s).
MEMORY FULL	<ul style="list-style-type: none"> There is no room left in memory to record a message. Erase some or all of the messages (p. 62, 68). The memory is full of received documents. Install a new recording paper roll (p. 19), or clear the jammed paper (p. 81).
NO RESPONSE	<ul style="list-style-type: none"> The other party's fax machine is busy or ran out of recording paper. Try again.
OUT OF PAPER	<ul style="list-style-type: none"> The unit ran out of recording paper. Install a recording paper roll (p. 19).
PAPER JAMMED	<ul style="list-style-type: none"> The recording paper is jammed. Clear the jammed paper (p. 81).
POLLING ERROR	<ul style="list-style-type: none"> The other party's machine does not have a polling feature. Check with the other party.
REDIAL TIME OUT	<ul style="list-style-type: none"> The other party's machine is busy or ran out of recording paper. Try again.
REMOVE DOCUMENT	<ul style="list-style-type: none"> The document is jammed. Remove the jammed document (p. 82).
TRANSMIT ERROR	<ul style="list-style-type: none"> A transmission error occurred. Try again.
UNIT OVERHEATED	<ul style="list-style-type: none"> The unit is too hot. Let the unit cool down.

Operations

When a function does not work, check here before requesting help

General

Problem	Cause & Remedy
I cannot make and receive calls.	<ul style="list-style-type: none">• The power cord or telephone line cord is not connected. Check the connections (p. 20).
I cannot make calls.	<ul style="list-style-type: none">• The dialing mode setting is wrong. Change to "TONE" or "PULSE" (p. 20).
The unit does not work.	<ul style="list-style-type: none">• Disconnect the unit from the telephone line and connect the line to a known working telephone. If the working telephone operates properly, contact our service personnel to have the unit repaired. If the working telephone does not operate properly, contact your telephone company.
The unit does not ring.	<ul style="list-style-type: none">• The ringer volume is set to off. Adjust it to a suitable level (p. 25).
The other party complains they only hear a fax tone and cannot talk.	<ul style="list-style-type: none">• The FAX ONLY mode is set. Tell them the number is used for faxes only or change to another mode (p. 42, 43).
The speakerphone is not working.	<ul style="list-style-type: none">• Use the speakerphone in a quiet room.• If you have difficulty hearing the other party, adjust the volume using  or .• If parts of your conversation are cut off, you and the other party spoke at the same time. Speak alternately.
The REDIAL/PAUSE button does not function properly.	<ul style="list-style-type: none">• If this button is pressed during dialing, a pause will be inserted. If pressed immediately after a dial tone is obtained, the last number dialed will be redialed.
The receive mode does not function as explained on pages 42 and 43.	<ul style="list-style-type: none">• A ring pattern detection is set (p. 50, 51).
During programming, I cannot enter the code or ID number.	<ul style="list-style-type: none">• All or part of their numbers are the same. Change the number (p. 53, 66).

Fax transmission

Problem	Cause & Remedy
I cannot send documents.	<ul style="list-style-type: none">• The other party's fax machine was busy or ran out of paper. Try again.• The other party's machine is not a facsimile. Check with the other party.• The other party's fax machine rings too many times. Send the fax manually - dial the number, confirm the fax tone, then press START/COPY/SET.

(continued)



Fax transmission

Problem	Cause & Remedy
The other party complains that letters on their received document are distorted.	<ul style="list-style-type: none"> ● If your line has special telephone services such as call waiting, the service may have been activated during fax transmission. Connect the unit to a line that does not have these services. ● The extension telephone on the same line is off the hook. Hang up the extension telephone and try again.
The other party complains that dirty patterns or black lines appear on their received documents.	<ul style="list-style-type: none"> ● The glass or rollers are dirty. Clean them (p. 84).
I cannot make an international fax call.	<ul style="list-style-type: none"> ● Use the overseas transmission mode (p. 40). ● Add two pauses at the end of the telephone number (p. 27).

Fax reception

Problem	Cause & Remedy
I cannot receive documents automatically.	<ul style="list-style-type: none"> ● The receive mode is set to the TEL mode. Set to the TAD/FAX, FAX ONLY or TEL/FAX mode. ● The time to answer the call is too long. Decrease the number of rings (p. 47, 49, 73). ● The greeting message is too long. Shorten the message (p. 59).
The display shows "CONNECTING" but faxes are not received.	<ul style="list-style-type: none"> ● The incoming call is not a fax. Change the receive mode.
The recording image is faint.	<ul style="list-style-type: none"> ● The sender transmitted a faint document. Ask them to transmit a clearer copy of the document. ● The thermal head is dirty. Clean it (p. 85).
The received document is blank.	<ul style="list-style-type: none"> ● The recording paper roll is installed incorrectly. Make sure that the shiny side of the paper is facing down and re-install the paper (p. 19).

Receive mode

Problem	Cause & Remedy
I cannot select the desired receive mode.	<ul style="list-style-type: none"> ● If you set the TAD/FAX or FAX ONLY mode: <ul style="list-style-type: none"> - Select the desired mode using feature #05 (p. 48), and - Press AUTO RECEIVE to turn on the AUTO RECEIVE light. <div style="text-align: right;">  </div> ● If you set the TEL or TEL/FAX mode: <ul style="list-style-type: none"> - Select the desired mode using feature #08 (p. 46), and - Press AUTO RECEIVE to turn off the AUTO RECEIVE light. <div style="text-align: right;">  </div>

Operations

Copying

Problem	Cause & Remedy
The unit does not make a copy.	● You cannot make a copy during programming. Try to make a copy after programming or stop the programming.
A dirty pattern or a black line appears on the copied documents.	● The glass or rollers are dirty. Clean them (p. 84).
The copied image is distorted.	● The thermal head is dirty. Clean it (p. 85).
The copied document is blank.	● The recording paper roll is installed incorrectly. Make sure that the shiny side of the paper is facing down and re-install the paper (p. 19).

Answering device

Problem	Cause & Remedy
No voice messages have been recorded in the TAD/FAX mode.	● The memory is full. Erase some or all the messages (p. 62, 68).
I cannot retrieve recorded messages from a remote telephone.	● Make sure that you use the remote operation ID correctly (p. 66).

If a power failure occurs

- The unit will not function.
- The memory contents will not be erased.
- When you set delayed transmission and the programmed start time has passed during a power failure, the transmission will be attempted after power is restored.

Clearing a recording paper jam

If the unit does not eject any recording paper during reception or copying, the recording paper has jammed. Remove the jammed paper as shown below.

- 1 Open the cover by pressing the cover open button. Then press the blue lever to release the paper cutter and remove the recording paper roll.

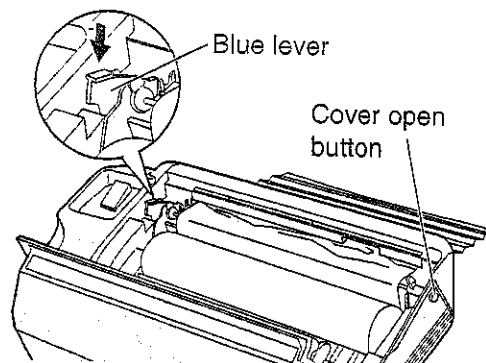

- 2 Cut off the wrinkled portion, and replace the recording paper roll in the proper direction.

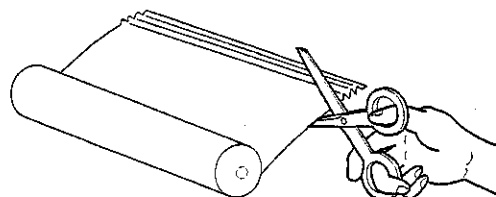

- 3 Insert the leading edge of the paper into the opening above the thermal head and pull it out of the unit.
 - Make sure that there is no slack in the paper roll.
 - If the paper cannot be inserted, try pressing the blue lever again.

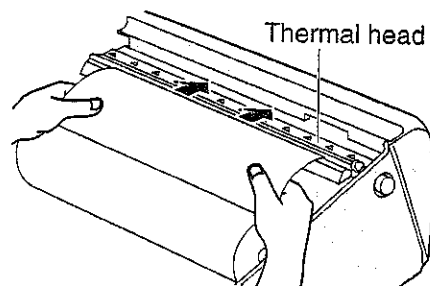

- 4 Close the cover securely by pushing down on both corners.

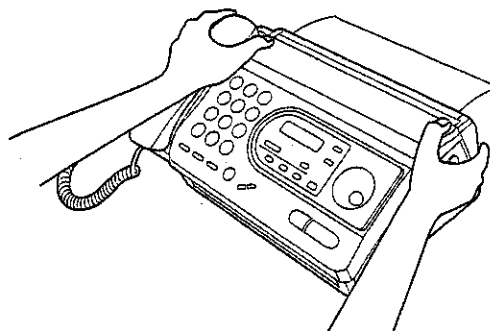

Note:

- When the power cord is connected, everytime you close the cover a message will be printed. If the recording paper is set to the wrong side, a message will not be printed. Install the paper correctly.

Help

Jams

When a document you are sending jams

If the unit does not release the document during feeding, remove the document as follows.

- 1 Open the cover by pressing the cover open button.
- 2 Remove the jammed document carefully.
- 3 Close the cover securely by pushing down on both corners.

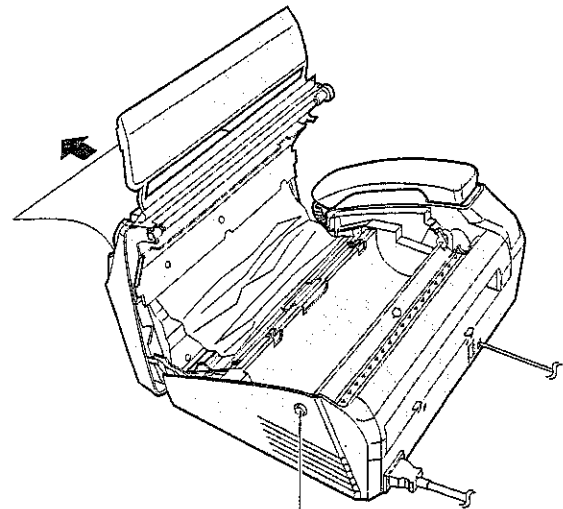

Cover open button

Note:

- Before opening the cover, do not pull out the jammed paper forcibly.

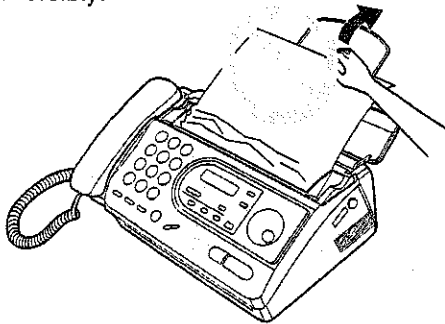

When documents you send do not feed, or multi-feed

If no feeding or multiple feeding occurs frequently, adjust the feeder pressure.

1 Open the cover by pressing the cover open button.

2 Shift the position of the lever by using an instrument with a pointed end, like a paper clip.

- Right:** When documents do not feed.
- Center:** Standard position (pre-selected)
- Left:** When documents multiple feed.

3 Close the cover securely by pushing down on both corners.

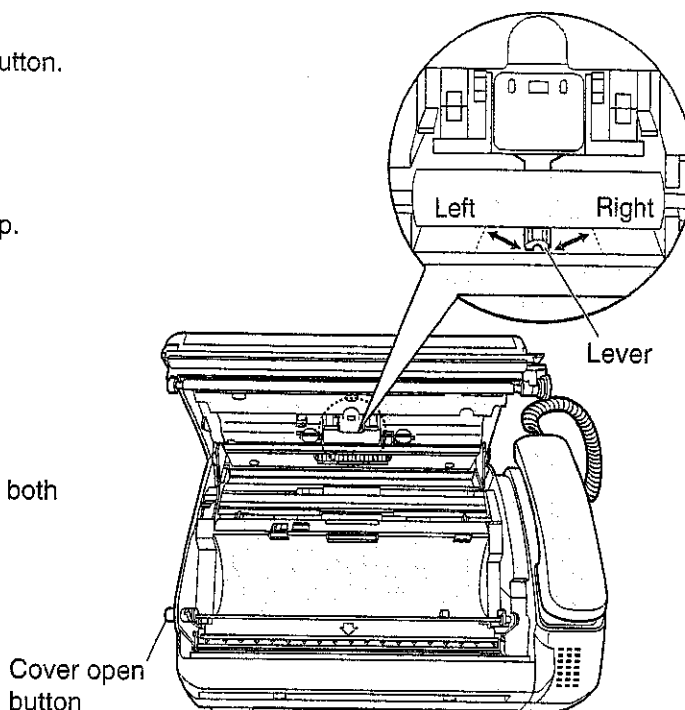

Cleaning

Cleaning the document feeder

If misfeeding occurs frequently or if dirty patterns or black bands appear on a copied or transmitted document, clean the document feeder.

- 1** Disconnect the power cord and the telephone line cord.
- 2** Open the cover by pressing the cover open button.
- 3** Clean the document feeder rollers, sub roller and rubber flap with a cloth moistened with isopropyl rubbing alcohol, and let all parts dry thoroughly.
- 4** Clean the white plate and glass with a soft dry cloth.
- 5** Close the cover securely by pushing down on both corners.
- 6** Connect the power cord and the telephone line cord.

Caution:

- Do not use paper products, such as paper towels or tissues, to clean the inside of the unit.

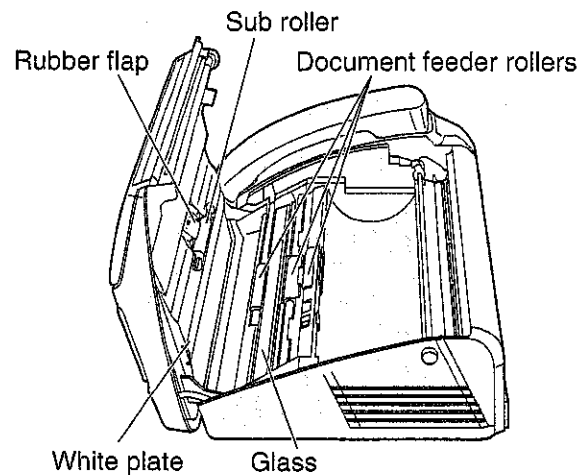
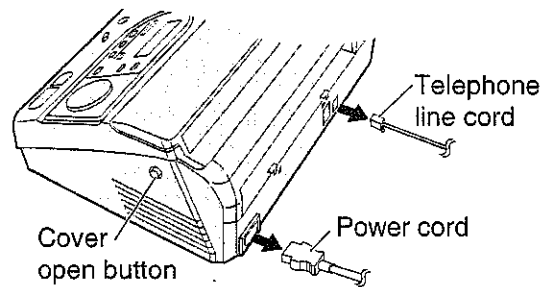

Cleaning the thermal head

If dirty patterns or black bands appear on a copied or received document, clean the thermal head.

- 1** Disconnect the power cord and the telephone line cord.
- 2** Open the cover by pressing the cover open button.
- 3** Clean the thermal head with a cloth moistened with isopropyl rubbing alcohol, and let it dry thoroughly.
- 4** Close the cover securely by pushing down on both corners.
- 5** Connect the power cord and the telephone line cord.

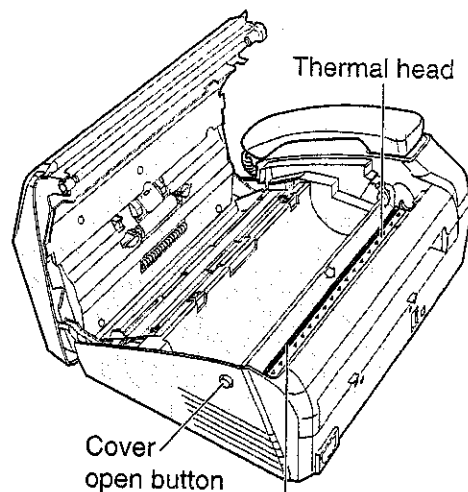

Caution:

- Do not push on the black cover.

Caution:

- To prevent a malfunction due to static electricity, do not use a dry cloth and do not touch the thermal head directly with your fingers.

Print Reports

Printing the feature settings, telephone numbers, and the journal

You can print out the following documents.

Basic feature list — provides you with the current settings of the basic programming features (see page 90).

Advanced feature list — provides you with the current settings of the advanced programming features (see pages 91, 92).

Telephone number list — provides you with names and telephone numbers which are stored in the EASY DIAL directory. The telephone number codes are as shown below.

P: A pause has been entered.

F: A recall has been entered.

[]: A secret telephone number has been entered. (The telephone number is not printed.)

Journal report — keeps records of fax transmissions and receptions. Also, this report will be printed automatically after every 35 fax communications (see page 38).

1 Press **MENU** two times.

Display: 2.PRINT LIST

2 For the **basic feature list**, press **[]**, then **[1]**.

BASIC LIST

For the **advanced feature list**, press **[]**, then **[2]**.

ADVANCED LIST

For the **telephone number list**, press **[]**, then **[3]**.

TEL NO. LIST

For the **journal report**, press **[]**, then **[4]**.

JOURNAL REPORT

3 Press **START/COPY/SET** to start printing.

PRINTING

- To stop printing, press **STOP**.
- After printing, the following will be displayed.

PRINT ITEM []

4 Press **MENU**.

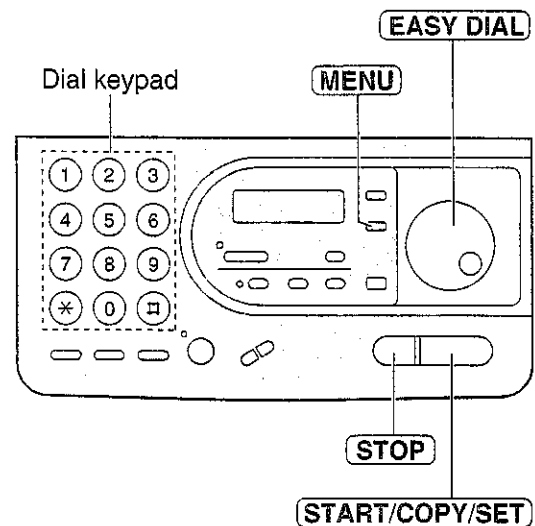

Note:

- In step 2, you can select the feature by rotating **EASY DIAL**.

Fax voice guidance

You can hear the transmission and reception results by the voice guidance. One of the following messages will be heard if this feature is set to on.

- *Transmission (Reception) is complete.*
- *Transmission (Reception) has failed.*
- *Transmission (Reception) has been interrupted.*

When friendly reception (see page 54) is activated, one of the following messages will also be heard.

- *Please hang up the handset for reception.*
- *Start reception.*

Changing the fax voice guidance setting

One of the following choices is available.

ERROR: The fax voice guidance will be heard only when fax transmission/reception and friendly reception fail.

ON: The voice guidance message regarding fax transmission/reception and friendly reception will be heard after every transaction (pre-selected setting).

OFF: The fax voice guidance will not be heard.

- 1 Press **MENU**.
Display: 1.SYSTEM SET UP
- 2 Press **[]**, then **4 7**.
FAX GUIDANCE
- 3 Press **START/COPY/SET**.
MODE=ON ▼▲
- 4 Press ▼ or ▲ to select the desired setting.
- 5 Press **START/COPY/SET**.
SETUP ITEM []
- 6 Press **MENU**.

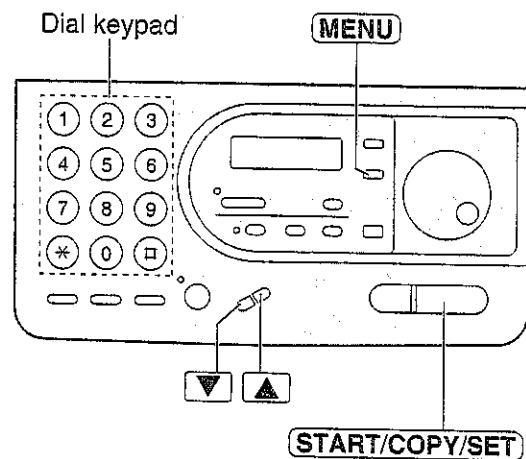

Display Contrast / Original Mode

Changing the LCD display contrast

Use this feature to adjust the display contrast.

NORMAL: (Pre-selected setting)

LIGHT: Used when the display contrast is too dark.

DARKER: Used when the display contrast is too light.

- 1 Press **MENU**.
Display: 1.SYSTEM SET UP
- 2 Press **#**, then **3** **9**.
LCD CONTRAST
- 3 Press **START/COPY/SET**.
MODE=NORMAL ▼▲
- 4 Press ▼ or ▲ to select the desired setting.
- 5 Press **START/COPY/SET**.
SETUP ITEM []
- 6 Press **MENU**.

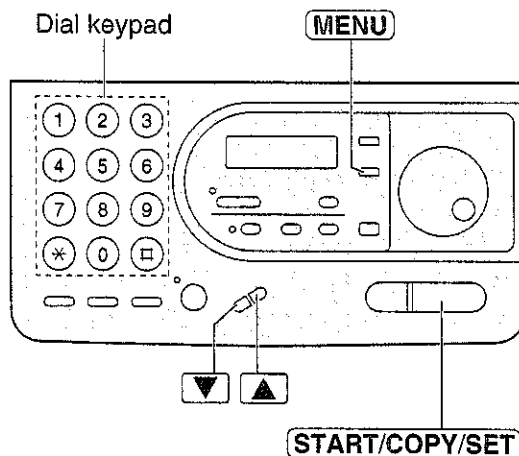

Setting the original mode

Use this feature when you need to transmit or copy a document with faint or dark writing.

One of the following choices is available.

NORMAL: Used for a document with normal writing (pre-selected setting).

LIGHT: Used for a document with faint writing.

DARKER: Used for a document with dark writing.

Set this feature before starting transmission or copying.

- 1 Press **MENU**.
Display: 1.SYSTEM SET UP
- 2 Press **#**, then **5** **8**.
ORIGINAL
- 3 Press **START/COPY/SET**.
MODE=NORMAL ▼▲
- 4 Press ▼ or ▲ to select the desired setting.
- 5 Press **START/COPY/SET**.
SETUP ITEM []
- 6 Press **MENU**.

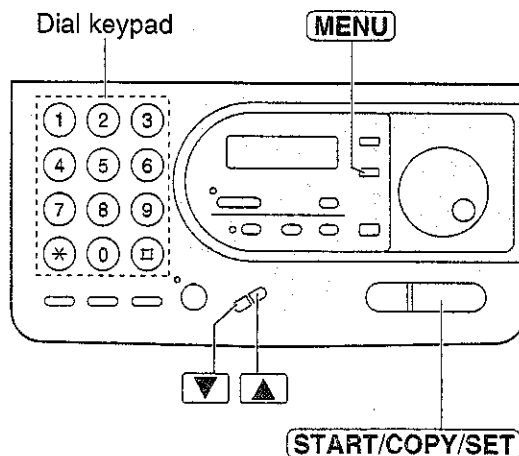

Note:

- This feature will return to the normal mode after transmission or copying is completed.
- These settings are available in the standard, fine and super fine resolutions.

Resetting the advanced features

Use this feature to return the advanced features (see pages 91, 92) to their pre-selected settings.

- 1 Press **MENU**.
 Display: 1. SYSTEM SET UP
- 2 Press **□**, then **8 0**.
 SET DEFAULT
- 3 Press **START/COPY/SET**.
 RESET=NO ▼▲
- 4 Press ▼ or ▲ to select "YES".
 RESET=YES ▼▲
- 5 Press **START/COPY/SET**.
 RESET OK?
- If this feature is not required, press **STOP**.
- 6 Press **START/COPY/SET** again for confirmation.
 RESET COMPLETED
 ↓
 SETUP ITEM []
- 7 Press **MENU**.

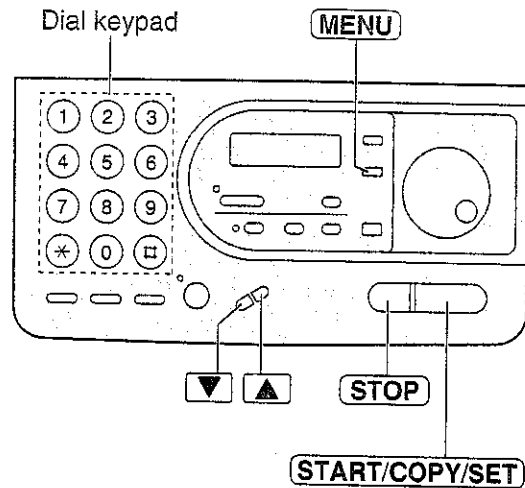

Features Summary

Summary of user programmable features

Basic features

Code	Feature & Display	Available settings	Meaning	Page
#01	Setting the date and time SET DATE & TIME	(2 digits for each entry)	mm/dd/yy hh:mm	21
#02	Setting your logo YOUR LOGO	(Up to 30 characters)		22
#03	Setting your facsimile telephone number YOUR TEL NO.	(Up to 20 digits)		24
#04	Printing the sending report TX-REPORT MODE	ERROR ON OFF	If transmission fails Activate Deactivate	37
#05	Changing the AUTO RECEIVE setting AUTO RECEIVE	TAD/FAX FAX ONLY	Telephone Answering Device /Facsimile mode Facsimile only mode	48
#06	Setting the ring count in the TAD/FAX mode TAD/FAX RING	2, 3, 4, 5, 6, 7, 8, 9 TOLL SAVER RINGER OFF	2 to 9 rings Saves you the charges for the call. Does not ring.	73
#07	Setting the ring count in the FAX ONLY mode FAX RING	2, 3, 4, 5, 6, 7, 8, 9	2 to 9 rings	49
#08	Changing the MANUAL RECEIVE setting MANUAL RECEIVE	TEL TEL/FAX	Telephone mode Telephone/Facsimile mode	46
#09	Setting the TEL/FAX mode ring count TEL/FAX RING	2, 3, 4, 5, 6, 7, 8, 9	2 to 9 rings	47
#10	Setting the caller's recording time RECORDING TIME	VOX 1 MIN	Unlimited 1 minute	74
#11	Setting the remote operation ID REMOTE TAD ID	ID=111	Any 3-digit number except a number using digits 0 or 7.	66

(The pre-selected value is in bold.)

Note:

- You can display the basic features in the order above by rotating **EASY DIAL** instead of entering the code number (#01, #02, etc.).

Advanced features

Code	Feature & Display	Available settings	Meaning	Page
#22	Setting the journal report to print automatically AUTO JOURNAL	ON	Activate	38
		OFF	Deactivate	
#23	Sending documents overseas OVERSEAS MODE	ON	Activate	40
		OFF	Deactivate	
#25	Sending a fax at a specific time DELAYED SEND	ON	Activate	39
		OFF	Deactivate	
#30	Setting the silent fax recognition ring count SILENT FAX RING	3, 4, 5, 6, 7, 8, 9	3 to 9 rings	47
#31	Setting the ring pattern detection RING DETECTION	ON	Activate	50
		OFF	Deactivate	
#39	Changing the LCD display contrast LCD CONTRAST	NORMAL	Normal contrast	88
		LIGHT	Lighter contrast	
		DARKER	Darker contrast	
#41	Changing the fax activation code FAX ACTIVATION	ON / CODE= * 9	Activate	53
		OFF	Deactivate	
#42	Setting the message alert MESSAGE ALERT	ON	Activate	74
		OFF	Deactivate	
#43	Setting the recording time alert REC. TIME ALERT	ON	Activate	75
		OFF	Deactivate	
#46	Setting the friendly reception FRIENDLY RCV	ON	Activate	54
		OFF	Deactivate	
#47	Setting the fax voice guidance FAX GUIDANCE	ERROR	If transmission/reception error occurs.	87
		ON	Activate	
		OFF	Deactivate	

(Pre-selected is in bold.)

(continued)

Features Summary

Advanced features

Code	Feature & Display	Available settings	Meaning	Page
#54	Setting the recording time for the TAD/FAX greeting message GREETING TIME	16s	16 seconds long	61
		60s	60 seconds long	
#58	Setting the original mode ORIGINAL	NORMAL	Normal contrast	88
		LIGHT	Lighter contrast	
		DARKER	Darker contrast	
#60	Setting the message transfer/pager call MESSAGE TRANS.	MESSAGE	Transfers incoming messages.	72
		PAGER	Calls your pager.	
		OFF	Deactivate	
#61	Recording the message transfer greeting message TRNS-GREETING	CHECK	Checks the greeting message.	71
		RECORD	Records the greeting message.	
		ERASE	Erases the greeting message.	
#67	Setting the ICM monitor ICM MONITOR	ON	Activate	75
		OFF	Deactivate	
#70	Signaling your pager when your unit receives a fax FAX PAGER	ON	Activate	55
		OFF	Deactivate	
#76	Setting the connecting tone CONNECTING TONE	ON	Activate	41
		OFF	Deactivate	
#80	Resetting the advanced features SET DEFAULT	YES	Reset	89
		NO	Will not reset	

(Pre-selected is in bold.)

Technical data about this product

Applicable Lines:	Public Switched Telephone Network
Document Size:	Max. 216 mm (8½") in width Max. 600 mm (23⅝") in length
Effective Scanning Width:	208 mm (8⅜")
Printing Paper Size:	216 mm × max. 30 m (8½"×98') roll
Effective Printing Width:	208 mm (8⅜")
Transmission Time*:	Approx. 15 s/page (Original mode) Approx. 30 s/page (G3 Normal mode)
Scanning Density:	Horizontal: 8 pels/mm (203 pels/inch) Vertical: 3.85 lines/mm (98 lines/inch) —STANDARD mode 7.7 lines/mm (196 lines/inch) —FINE/HALF TONE mode 15.4 lines/mm (392 lines/inch) —SUPER FINE mode
Halftone Level:	64-level
Scanner Type:	Contact Image Sensor (CIS)
Printer Type:	Thermal Printing
Data Compression System:	Modified Huffman (MH), Modified READ (MR)
Modem Speed:	9,600 / 7,200 / 4,800 / 2,400 bps; Automatic Fallback
Operating Environment:	5–35 °C (41–95 °F), 45–85 % RH (Relative Humidity)
Dimensions (H×W×D):	135 × 323 × 229 mm (5⅝"×12⅔"×9")
Mass (Weight):	Approx. 2.9 kg (6.4 lb.)
Power Consumption:	Standby: Approx. 7.5 W Transmission: Approx. 20 W Reception: Approx. 40 W Copy: Approx. 40 W Maximum: Approx. 125 W
Power Supply:	220-240 V AC, 50/60 Hz
Memory capacity:	Approx. 20 minutes of recording time including the greeting message when no fax documents are in memory.** OR Approx. 20 pages of document memory based on CCITT No.1 Test Chart in standard resolution when no voice messages have been recorded.***

* Transmission speed depends upon the contents of the pages, resolution, telephone line conditions and capability of the receiving unit.

The 15 second speed is based upon CCITT No.1 Test Chart.

** Recording time may be reduced by the caller party's background noise.

*** If both fax documents and voice messages are recorded in memory, the corresponding capacities above will be shortened.

CCITT No.1 Test Chart

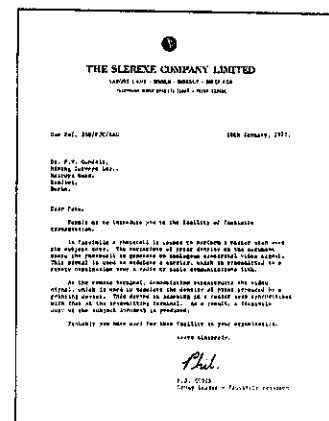

Note:

- Any details given in these instructions are subject to change without notice.
- The pictures and illustrations in these instructions may vary slightly from the actual product.

Index

A	Accessories	4	Feeder (Cleaning)	84
	Advanced features	91, 92	(Jam)	82
	(Resetting)	89	(Pressure)	83
	Alert (Message)	74	Friendly reception	44, 54, 87
	(Recording time)	75	G	
	AUTO RECEIVE button	42, 43	Greeting message (Message transfer)	70
	AUTO RECEIVE mode	43	(TAD/FAX)	58, 59
B	Basic features	90	(TEL/FAX)	59
C	Caller's recording time	74	H	
	Character table	23, 29	Handset receiver volume	25
	Cleaning	84, 85	HELP button	5
	Communication messages	76	Hyphen key	29
	Connecting tone	41	I	
	Connections	20	ICM monitor	75
	COPY button	56	Insert key	22, 23, 29
D	Date and time	21	J	
	Delayed transmission	39	Jam	81-83
	Dialing mode	20	Journal auto print	38
	DIRECTORY EDIT button	28, 30	Journal report	38, 86
	Directory feature	28, 31, 34	L	
	DIGITAL SP-PHONE button	26, 32	LCD contrast	88
	Display contrast	88	List (Advanced feature)	86
	Distinctive Ring service	50, 51	(Basic feature)	86
	Document feeder cleaning	84	(Journal report)	86
	Document jam	82	(Telephone number)	86
	Document size	35, 93	Location panel	16, 17
E	EASY DIAL (Making a voice call)	31	Logo	22
	(Repeating the recorded messages)	63	M	
	(Selecting characters)	23, 29	MANUAL RECEIVE mode	42
	(Sending faxes)	34	Message alert	74
	(Skipping the recorded messages)	63	Message transfer	70
	(Storing)	28	MUTE button	26
	ERASE button	60, 62	N	
	Error messages	76, 77	NAME/TEL NO. key	31
	Extension telephone	46, 52	O	
F	Facsimile telephone number	24	Original mode	88
	FaxAbility	50	Overseas transmission mode	40
	Fax activation code	53	Overview	18
	Fax auto redial	34	P	
	FAX ONLY mode	43, 48	Pager call	55
	FAX ONLY ring count	49	Paper jam	81
	Fax pager	55	Paper stacker	19
	Fax voice guidance setting	87	PAUSE button	27
	Fax voice guide	36	PLAY MESSAGES button	62
	Features summary	90-92	Polling (Receiving)	54
			(Transmitting)	40
			Power failure	80
			Power supply	20, 93
			Printing paper size	93

- Printing reports86
 Problem solving78-80
 Programmable features90-92
 Pulse20
- Q** QUICK button63
- R** RECALL button27
 Receiving (FAX)10, 44
 (Setting)42, 43
 RECORD button59, 64
 Recording (Greeting message)59
 (Memo message)64
 (Telephone conversation)64
 Recording paper4, 19, 81
 Recording paper jam81
 Recording time alert75
 Recording time for TAD/FAX greeting
 message61
 REDIAL button26, 33
 Remote operation ID66
 REPEAT button63
 Report (Advanced feature)86
 (Basic feature)86
 (Journal)38, 86
 (Sending)37
 (Telephone numbers)86
 Reset89
 RESOLUTION button33
 Ring count (FAX ONLY)49
 (TAD/FAX)73
 (TEL/FAX)47
 Ring pattern detection50, 51
 Ringer volume25
- S** Secret key28, 29
 Set default89
 Silent fax recognition ring47
 SKIP button63
 SLOW button63
 Speaker volume25
 Specifications93
- T** TAD/FAX mode43, 57
 TAD/FAX ring count73
 TEL mode42, 44
 TEL/FAX mode42, 45
 TEL/FAX ring count47
 Telephone line cord4, 20
- Telephone number list86
 Thermal head cleaning85
 Toll saver73
 TONE20
 TONE button27
 Transmission report37
 Transmittable document35
- V** Voice call (Answering)26
 (EASY DIAL)31
 (Making)26
 Voice contact32
 Voice time/day stamp62
 VOLUME button25

For your future reference

Date of purchase

Serial number

(found on the back of the unit)

Dealer's name and address

Dealer's telephone number

Kyushu Matsushita Electric Co., Ltd.

1-62, 4-chome, Minoshima, Hakata-ku, Fukuoka 812-8531, Japan

Printed in Malaysia

PFQX1242ZA

WM0898AN0